

OPTIMIZATION OF INJECTION MOLDING PROCESS PARAMETERS TO MINIMIZE DEFECTS IN RADIATOR GRILL USING TAGUCHI BASED METHOD IN MOLDFLOW SOFTWARE

¹Shubham Bhagwan Sonone, ²Dr.A.Muthuraja,

¹Student, ²Associate Professor,

¹Mechanical Department,

¹Sandip University, Nasik, India

Abstract : In this paper, an attempt has been taken to study and identify the possible defects in radiator grill which cause due to varying molding parameter in plastic injected molded component in PIM using Autodesk moldflow simulation software. Injection molding is one of the most productive method of manufacturing a plastic component. Material properties, part design, mold design, and processing condition are factors influencing variations in the part defects. Molding condition or process parameter play a decisive role that affects the quality and productivity of plastic products. In Design of Experiment (DOE) Variable Influence (Taguchi) Method is the best practice for synchronized study on factors which contribute on the quality of the end product by which we can conclude on process parameter. On these experiment we got Optimized parameters which have reduced the weld line, short shot, flow marks, flash in the end product with better quality of product then the traditional method of molding.

IndexTerms - Injection molding ,process parameter taguchi method, S/N curve, Taguchi Method.

I. INTRODUCTION

Injection molding is the most significant process for manufacturing plastic product. The manufacturing plastic products within the budgeted cost, quality and time are a major concern in PIM industries. To address this the answer is virtual manufacturing Here we are going to present a typical scenario of radiator grill of bolero. These plastic component is injection molded using acrylonitrile-butadiene-styrene. The component is large and thin walled so the tendency to short shot, shrink, warp and flask is more. When Moldflow simulation technology was introduce, its primary purpose was to search for remedies to pre-existing molding problem during the design process. CAE technology helps save time, money row material, as well as cuts scrap, reduces the rejection rate, improve product quality, and get new products to market faster.

From the available literatures, it was observed that the parameters such as thermal effect, pressure effect, and geometry effect, and flow orientation effect are influencing the part quality. To understand the suitable option, the design of experiments to be conducted. For the last two decades, the analysis of the PIM component has been carried out using the mold flow analysis.

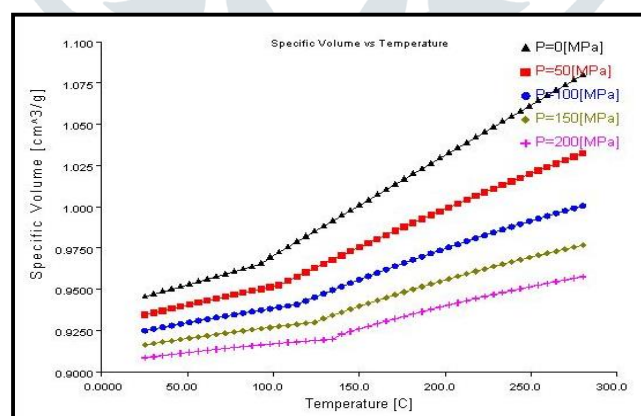

fig.1 PVT diagram of ABS

Moayyedian *et al.* (2017) analyzed short shot possibility in injection molding process by using Solid Works plastics and Taguchi method. The result from experimental and simulation revealed that melt temperature and filling time were the influential parameters about 74 % and 22% respectively on short shot.

Sanchez *et al* (2012) related the cooling setup and warpage in injection molding process. it was concluded that as cooling time is increased without any change in cooling condition, warpage could become lower. when injection temperature is 230° C, and cooling time is 20 s instead of 12 s, maximum deflection is reduced about 6% and if cooling time is increased until 28s the deflection decreases up to 30% and also conclude that cooling times was the more significant parameter to reduce warpage. The injection molding process is typically divided into 4 stages mainly filling, packing, cooling and ejection. Among all these stages, cooling takes longest time and majority of defects occurs due to the improper cooling parameter. Dang *et al.* (2014) given the General framework for Optimization of plastic injection molding process parameters and focuses on simulation -based optimization. The simulation-based optimization result can be used as a reference data ,and it should be verified in the real injection molding .

H.Oktem *et al.* (2012) Optimized the Process conditions on shrinkage of an injected-molded part of DVD-ROM cover using robust method in that Taguchi method is used for finding optimum combinations of process condition which evaluating the defect of shrinkage in PIM. also suggested that the signal-to-noise (S/N)ratio is utilized to determine the optimum combination of the process condition for shrinkage through analysis of variance (ANOVA). Fu *et al* (2019) predicted early-ejected plastic part air-cooling behavior towards quality mold design and less molding cycle time. A moldflow -Ansys integrated FEA method is used to simulate the air cooling process so that air-cooling shrinkage can be considered at the early design stage and quality of the part can be ensured with less molding cycle time. The cost factor of molding cycle time can be considered at the mold design stage and a cost effective design can be developed.

Nian *et al* (2015) studied the warpage control of thin-walled injection molding using local mold temperature in that the neutral axis theory is introduced to analyze the temperature distribution in the cross section of the part and then predict the warping trend.

2. ANALYSIS USING MOLDFLOW

There are few things we need to know about the part to be molded before starting the analysis. The part material ,the machines available with the molding shop to mold the component. The mold construction type, the runner system to be adopted ,the positioning of the gate, the quality to be produced some benchmark data from similar mold to compare the output data with. The part to be molded shown in fig 2.and fig.3 as below.

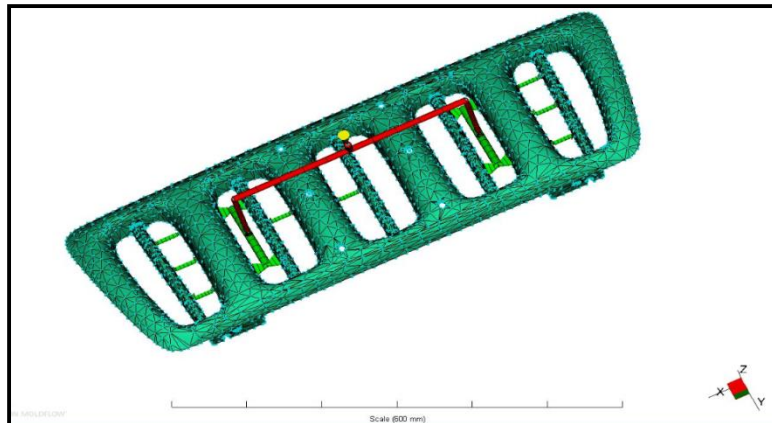

fig 2.Component model rendered view with sprue attached on radiator grill

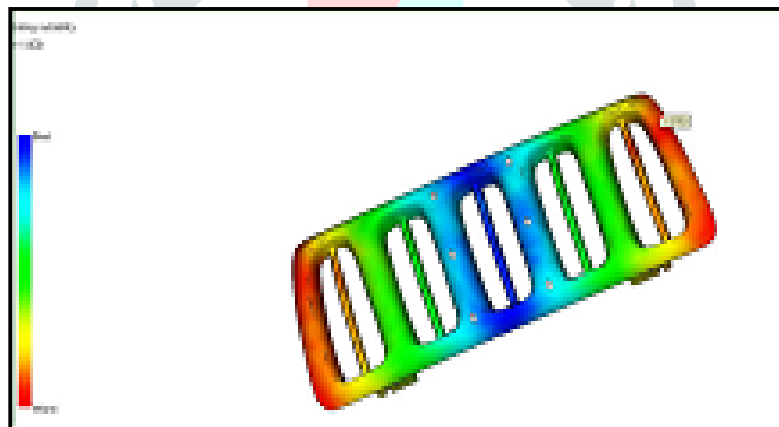

fig 3. Gating suitability analysis for radiator grill

All data about the part collected properly .The first analysis was to see the molding feasibility of the part which can be done in any 3D modeling software CATIA , SOLIDWORK , etc. after that we so for meshing for checking the connectivity of part and make it infinite to finite DOF with the help of hypermesh software after that we go for mold flow simulation.

The preliminary study using moldflow advisor was able to detect the molding suitability with respect to the draft angle ,wall thickness and wall thickness variations. Mold flow analysis (MFA) software simulates the plastic flow, allowing you to enhance mold design and create the highest quality products possible. This analysis provides a virtual sneak peek into how the chosen material will fill a mold's cavities and highlights potential areas of concern.

The required clamping tonnage (C_t) was calculate using the equation 1below.

$$C_t = A_p * P_i / 10000$$

where A_p is projected area of part in cm^2 , p_i is the injection pressure which is 35000KPa for thin walled part. A mould flow synergy was used to do the rest of the analysis. A fill+pack+warp analysis was done to determine the basic molding condition and see the possibility of optimizing the cooling system to solve the warpage issues and to reduce the possible defects. From the material which we select on that basis moldflow software suggest a suitable processing parameter value shown in fig 4.and mechanical properties of material are shown in fig 5 as below:

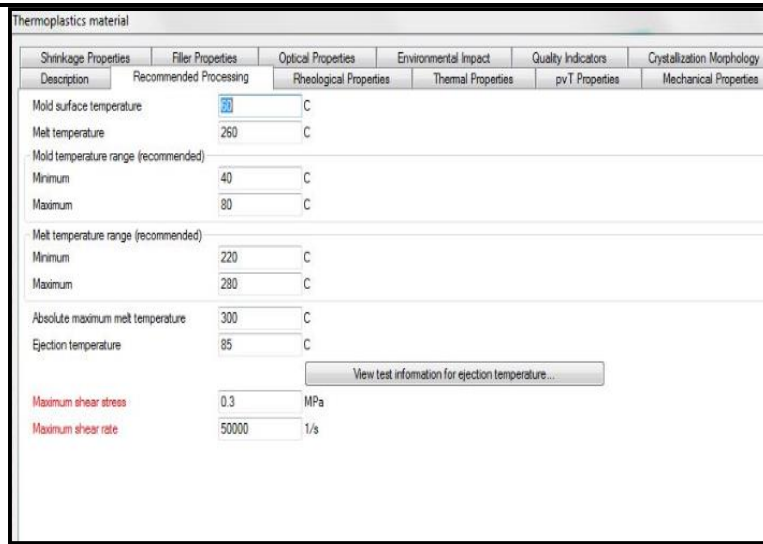

fig 4.Recomended Process parameter for ABS for radiator grill.

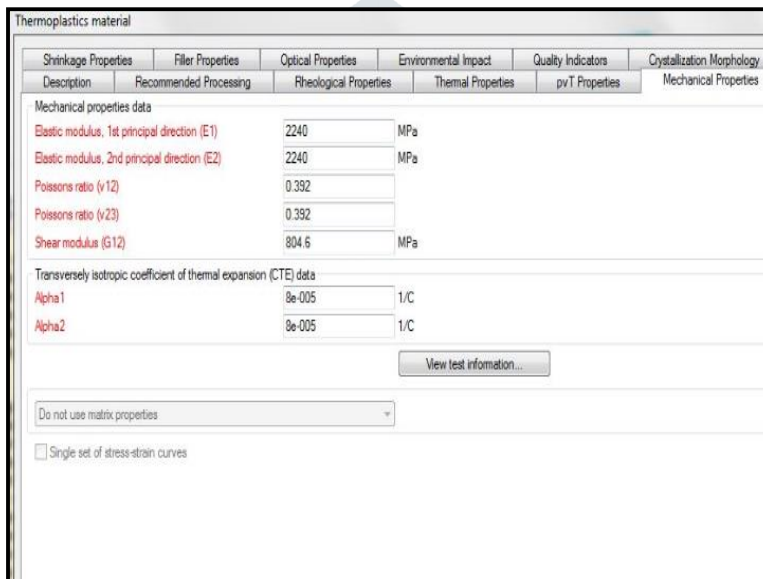

fig 5.mechanical properties of ABS material

3. RESULT AND DISCUSSIONS

The following are the result of the preliminary analysis using moldflow simulation software. Time required to fill the cavity for radiator grill is shown in fig 6,

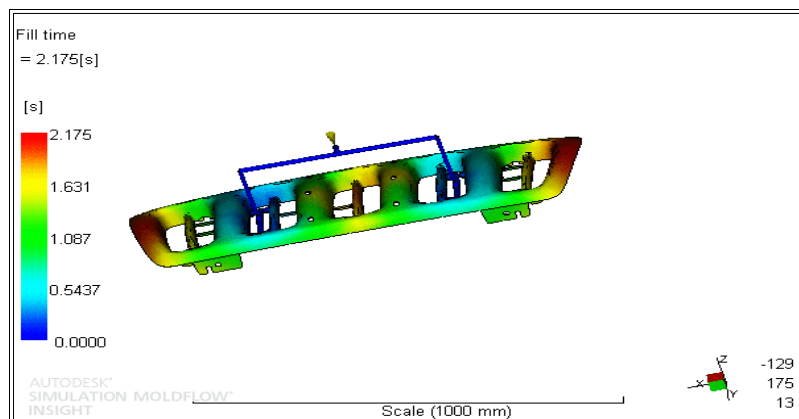

fig 6 Estimated cavity filling Time for radiator grill

The cavity fill in 2.176 seconds on a SP700 tonn machine with injecting pressure of 85 Mpa. On the fill time result, a short shot will appear as a translucent, If a fill time result shows a section where the contours are very closed spaced, hesitation may occurred. Hesitation can cause a short shot if a thin section freezes off before the part is completely filled. If a Fill time result shows that one flow path finishes before others do, it may indicate over packing. Over packing can cause high part weight, warpage, and non-uniform density distribution throughout the part . The Confidence of Fill result indicates this area of the part may be difficult to fill with plastic. If the part consist of thin and complex geometry, this can cause filling difficulties which required high injection pressure to complete filling.

The maximum clamp force is required to keep the mold close during filling. It is witnessed that the obtain clamping force is a function of injecting pressure and the projected area of the part as shown in fig.7

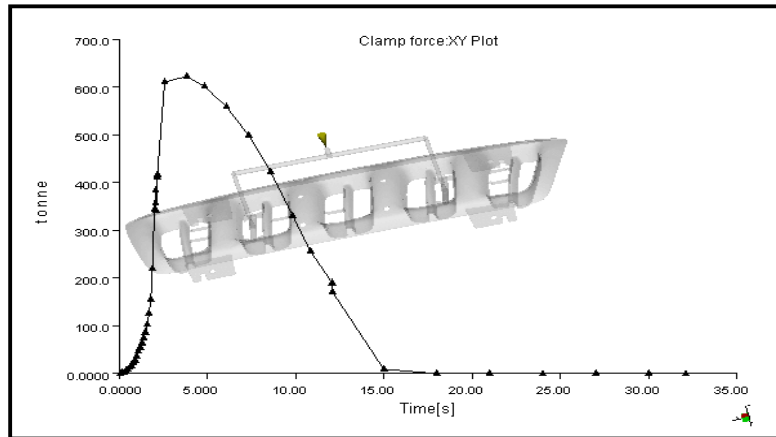

fig.7 Clamping force plot for radiator grill

manually calculated clamp force, using the maximum injection pressure and the projected area of the cavity is higher than the simulated clamping force in Autodesk simulation moldflow which is 620 tonne. while doing molding select the machine which have more clamp force capabilities.

A Short shot of molten polymer initially fills 75-98% of mold cavity under ram speed control of injection molding machine. Used to vary the ram movement during the filling phase of the injection cycle. ram speeds that offer compromises shown in the fig

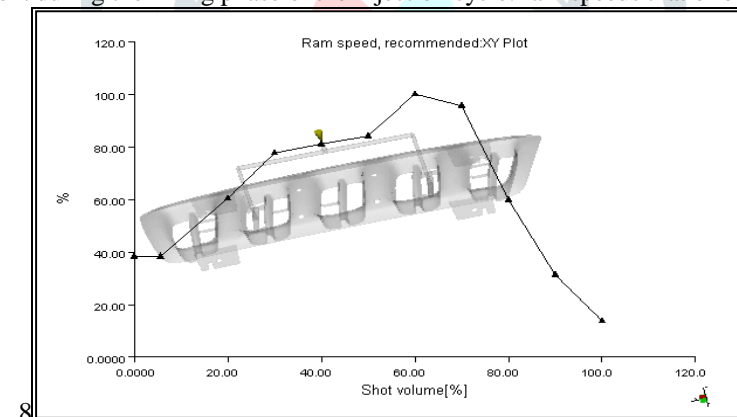

fig .8 Ram speeds for radiator grill

The larger the flow front area ,the higher the ram speed needed to maintain a constant flow front velocity.

Weld lines are formed when two flow fronts meet head on so it is cannot be minimize completely but it is shifted to back face of the component so they are less visible by designing a proper gate /runner system. flow analysis can show the weld line location shown in fig. 9

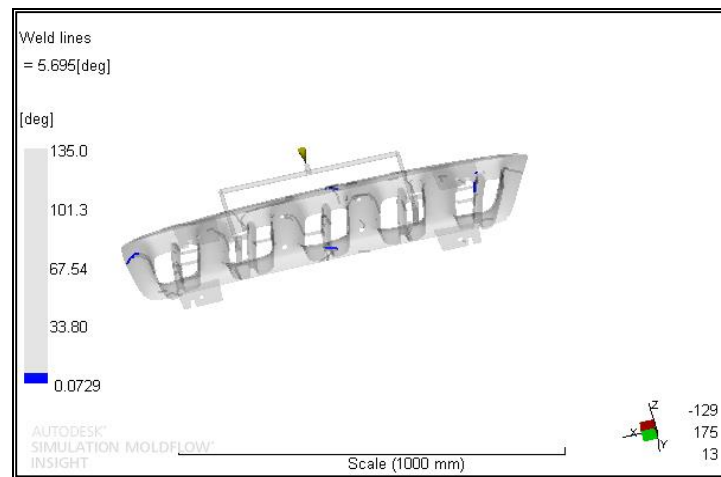

fig .9 weld line location plot for radiator grill

In recent study the maximum degree of weld depth is 0.0729 which is not visible with normal eye. so here moldflow help to predict and help to reduce weld line.

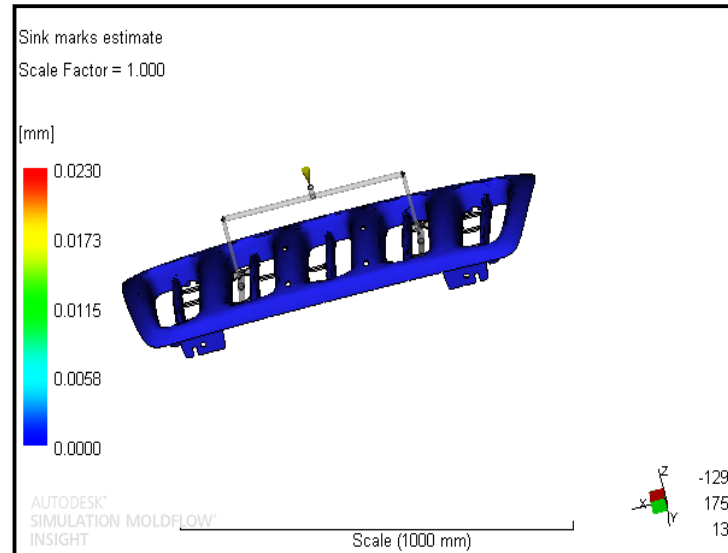

fig .10. sink mark estimate for radiator grill

Sink mark estimate result displays simulated sink marks on the part. It also displays the calculated depth of the sink marks in the parts. These result indicate the presence and location of the sink mark. Increase the size of gates and runners to delay the gate freeze-off time.

4. Conclusion

Mold Flow analysis of the part has greatly helped in reducing the cycle time to mold the part. Issues with the sinkmark, Warpage, Injecting pressure, short shot dealt with to a great extent. The molding cycle was optimized so that a part with the best quality with no defects can be produced by pre analysis with the help of moldflow software. some conclusive point are, We run the optimization technique Taguchi method in Mold flow software where we get the actual processing parameter value by putting the maximum and minimum value of processing setting. These analysis has saved several man hours of trouble shooting and rework of molding process. For the analysis of material behavior in modling and pre analysis of defects in molded component moldflow software plays an important role.

REFERENCES

1. Mehdi Moayyedean, Kazem Abhary, Romu Marian, "The analysis of short shot possibility in injection molding process." Int J Adv Manufacturing Technol (2017) 91:3977-3989
2. R.sanchez, J.aisa, A.Martinez, D.Mercado, "On the relationship between cooling setup and warpage in injection molding," measurement 45 (2012) 1051-1056
3. Xuan-Phuong Dang, "General frameworks for optimization of plastic injection molding process parameters, simulation molding practice and theory" 41(2017) 15-27
4. H.Oktem, " Optimum process condition on shrinkage of an injected-molded part of DVD-ROM cover using Taguchi robust method", Int J Adv Manufacturing Technol (2012)61:519-528
5. S.Sanchez-caballero,M.A.Selles,S.Ferrandiz,M.A peydro,B.A.Oliver, "Failure analysis of a plastic modular belt in -service ",Engineering failure analysis 93(2018)13-25.
6. Junyu Fu,Yongsheng Ma, " A methode to predest early -ejcted plastic part air -cooling behaviour towards quality mold designand less molding cycle time",Robotics and computer integrated manufacturing 56(2019)66-74
7. Sang Hun Lee, " Feature-based non-manifoldmodeling system to integrate design and analysis of injection molding products",Journal of mechanical science and Technology 23(2009)1331-1341
8. Shih-Chaih Nian,Chih-yang Wu,MIng-Shyan Huang,"warpge control of thin -walled injection molding using local mold Temperature ",International communications in Heat and Mass Transfer 61(2015)102-110.
9. Xuanping Wang , Xikui Li .Numerical simulation of three dimensional non-Newtonian free surface flows in injection molding using ALE finite element Method .finite element in analysis and design 46(2014).
10. Muhammad Khan, S. Kamrn Afaq. Cycle Time Reduction in Injection Molding Process by Selection of Robust Cooling Channel Design. ISRN-Mechanical Engineering.