

ONLINE LIBRARY MANAGEMENT SYSTEM

**1.NAMBURI SAI NAGA LAKSHMI
PRASANNA**

Dept of CS ,
SVKP & Dr K S Raju Arts & Science
College, Penugonda, A.P, India,

2.B.N.SRINIVASA GUPTA

Associate Professor,Dept of CS,
SVKP & Dr K S Raju Arts & Science
College, Penugonda, A.P, India.

ABSTRACT

As the library and information services community seeks to cope with new patterns of information provision, new technology and changing financial circumstances, it is critical to gain new thinking across the profession. The Latest research, innovative theory and best organizational practice are all presented in Library Management System.

Library Management System website which is used to supply the books to the user. This is done through JAVA technologies. This has various technical areas. It includes WINDOWS XP as the operating System, Oracle as Database. The front end deals with GUI and source code deals with Oracle (Backend).

Library Management System provides knowledge and practical perspectives all aspects of management of libraries and information services, which will prove invaluable to managing a library or information services cost effectively, while meeting the needs of its users.

Library Management System is one of the most tedious processes, which involves the regular updating of many files and records. As new

members enroll for membership the management has to issue a unique membership code for that member. For this they have to keep a track of many records such as student details, book details and maintain a number of registers. Doing this manually involves a lot of time and labor. Hence this can be made easy through automation.

1. INTRODUCTION

1.1 Vision

The Interface has to be simple to use, as the target end-users for the system are non-technical persons. Our system also aims to provide a complete IT solution in managing a library.

This system aims to automate the functions performed by the librarian. Operations such as cataloguing the books, Managing Member Information, Searching books, Issuing books, collecting fines etc are included in this system. Our system aims to provide powerful functionalities to the user by making use of simple easy-to-easy interface.

1.2 Scope

- Library Management System is website used to provide information regarding the books in a library to the user.

- It can be accessed by unlimited number of users.
- Each user will be assigned a different set of permissions for each module of the library including basic searching, permissions, advance booking etc.
- The user can take of use his required books up to the time limit extended to him.
- At the cross of his time limit he may face the fine.
- Fine session is under the control of administration.
- The administrator has to generate daily/weekly/Monthly reports, which include the details of books, issued, returned, collection of fine etc..

2. OVERVIEW OF THE SYSTEM

2.1 Existing System

A library is an ideal candidate for an IT solution, given the huge amounts of data it has to deal with on a day-to-day basis. Library is a place that enters to the needs of book lovers. In the current system all the details of the books in the library are maintained in the books. If the management want to search a record of the book they has to search all the records. If the management wants to add a new book in to the database they have to search to which category the book belongs to. User has to know the availability of the book before issuing to the student.

Student must come to the library to know the status of the book. If the book is not available the student will make it as advance booking. In the current system there is a malfunctioning of that

feature, because one student can use advance booking option one or more times for the same book, and the person who had the book can also use the advance booking feature for the same book. If the students want to know the status of the book they have to come to the library and they will know the status. The whole process is now manually controlled. This requires maintaining the records of the queries coming from the students in the paper.

2.2 Limitations in Existing System

Maintaining the data in excel sheets and files is very hard to remember the file names in which the required data is feed. No easy access to the required queries. Data redundancy, inconsistency, lot of human work need to be done in order analyze the details present in the excel sheets. It leads to wastage of time. No timely response to the end users.

2.3 Proposed System

Proposed system is the one that is going to be automated, so that it is easy to retrieve the responses from the system fastly and updating the details once the response or services are provided to the end-users upon their request without any difficulty and saves time.

Library is a place that caters to the needs of book lovers. Managing a library is no easy task due to advent of digital and web libraries it has become indispensable to use computers in management of a library.

2.4 Advantages over Existing System

- The proposed system is automated that is faster than the existing manually maintained system and can handle data easily.
- Computerization of the details of the members and books.
- The System allow administrator to control roles and accessibility of other users.
- Maintenance time and cost are greatly reduced.
- Accurate information can be generated easily and quickly at different levels.
- Report can be generated easily and quickly.

2.5 Features of the proposed system:

- User friendly.
- User can get the Timely Information from the database with out any delay regarding the query.
- This reduces the delay of response given to the Customer.
- User can generate reports very easily.

2.6 Modules:

Admin module - Has full access to all the modules of this system. Responsible for creating, modifying and deleting a member and book, admin can view the catalog and also will generate the reports.

Reports:

All frequently used reports at the click of a button
All reports can be previewed, printed, exported to Excel/Word etc., or can be faxed or emailed

User (Assistant) Module: – Has restricted access. i.e., users have access to some of the modules only i.e. user can view the catalog, and can issue the book, search for a book, renew a book, return a book and can send mails to the admin regarding any issue related to the books.

Student: Members have maximum rights but they are also restricted to some extent by the admin. They can view catalog and search for any book in the list, send mails to the admin and can reserve a book in advance.

Book Management Module: in this module administrator can add, delete and modify the books and journals. And also he can add different type of category books with ISBN number.

Security and Authentication Module:

System provides security with different kind of accessing levels. Admin can also take backup file to recover the data. This can check the login name and password against to the database to prevent unauthorized accessing. It provides the facility to change password.

3. SYSTEMDESIGN

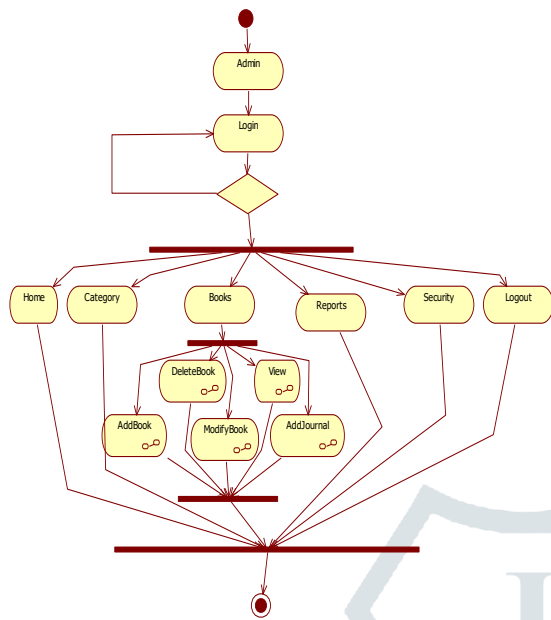

Fig 3.1: Admin Activity Diagram

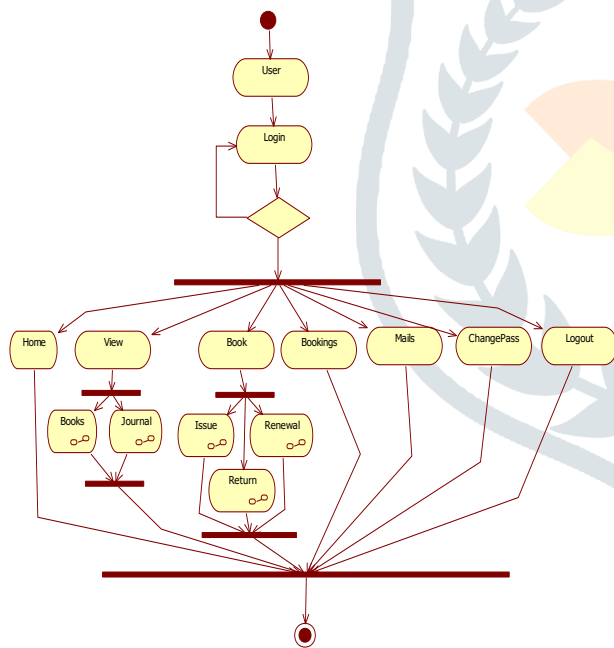

Fig 3.2: User Activity Diagram

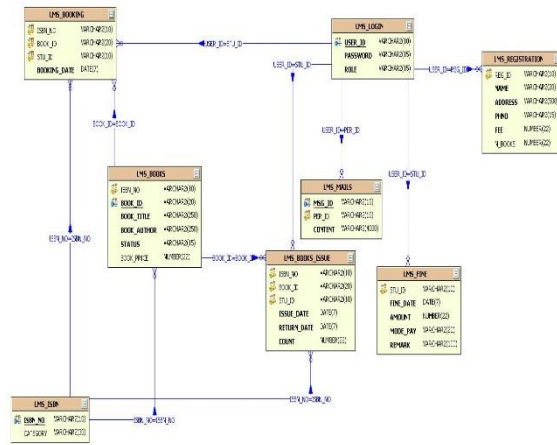

Fig 3.3: ER Diagram

4. OUTPUT SCREEN SHOTS

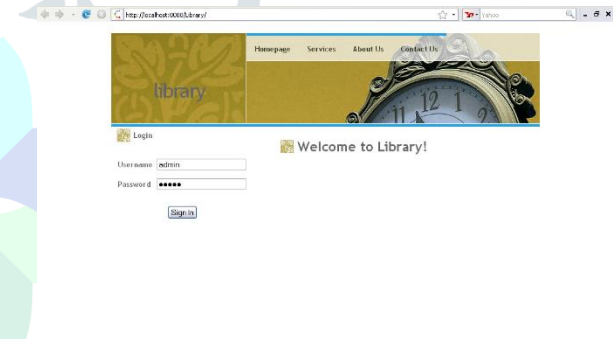

Fig 4.1: Home Page

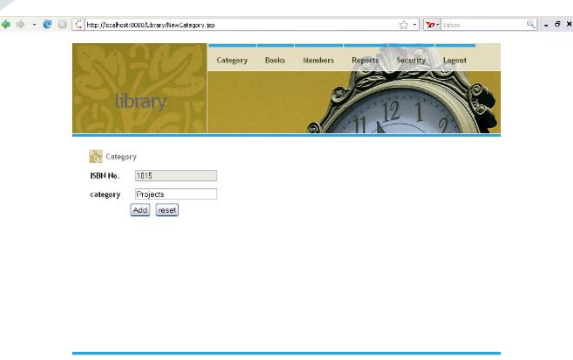

Fig4.2: CategoryPage

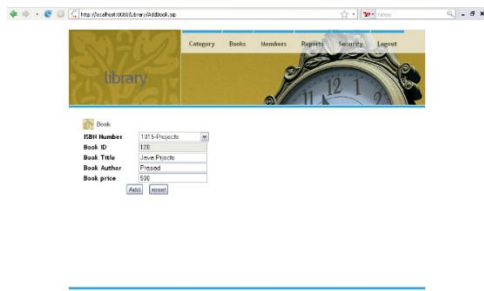

Fig4.3: BooksPage

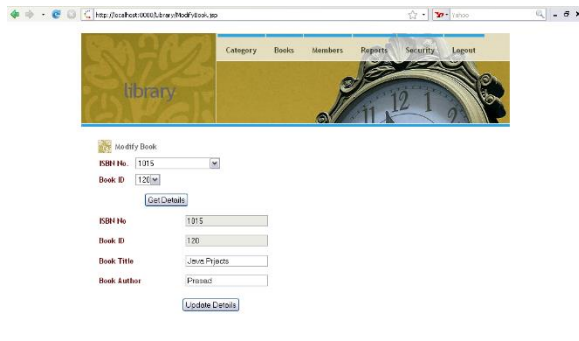

Fig 4.4: Modify Books Page

5. CONCLUSION

The “**Online Library Management System**” was successfully designed and is tested for accuracy and quality.

During this project we have accomplished all the objectives and this project meets the needs of the organization. The developed will be used in searching, retrieving and generating information for the concerned requests.

6. REFERENCES

- 1.Prasanna Pillai, Sonal Singh, Shreya Thakare “Android Application for Library Automation”.
- 2.Akaze Maureen and Ojeme Blessing “ Design of Automated Library Management System for States Universities in Nigeria “ .

3.R.Dinesh, S.R.ArunPravin, M.Aravindhan, D.Rajeshwari. “Implementing BRICKS, a Digital Library Management System “.

4.R.Dinesh, S.R.ArunPravin, M.Aravindhan, D.Rajeshwari. “Library Access System Smartphone Application Using Android ”.

5.Bhupendra, Shraddha Panwar, Vijay Vaishnav. “ Online Library Management System ”.

6.Tao Zhang, XiNiu and Marlen Promann.” Assesing the user Experience of E-Books in Academic Libraries ”.

7.Marci D. Brandenburg, Sigrid Anderson Cornell , Justin Joque , Mark P, MacEachern ,and Jean Song. “

Interdisciplinary Collaboration: Librarian Involvement in Grant Projects “.

8.Jannette L. Finch and Angela R. Flenner.” Using Data Visualization to Examine an Academic Library Collection “.

9.L.J. Haravu, “ Emerging Initiatives in Library Management Systems ”.

10.Ningning Kong, Michael Fosmire and Benjamin Dewayne Branch. “ Developing Library GIS Services for Humanities and Social Science: An Action Research Approach “.

About Authors:



Namburi Sai Naga Lakshmi Prasanna is currently pursuing MCA SVKP & Dr K S Raju Arts & Science College, Penugonda, West Godavari District A.P. Her research interests include Data

Mining, Artificial Intelligence.



B.N.Srinivasa Gupta is working as Associate Professor in SVKP & Dr K S Raju Arts & Science College, Penugonda, A.P. He received Masters Degree in Computer Applications from

Andhra University and Computer Science & Engineering from Jawaharlal Nehru Technological University Kakinada (JNTUK), Kakinada, India. His research interests include Data Mining, Cyber Security, Artificial Intelligence.

