

# POWER QUALITY IMPROVEMENT IN A SYNCHRONOUS GENERATOR BASED DIESEL-PV HYBRID MICRO GRID USING ADAPTIVE FILTER CONTROL SCHEME

<sup>1</sup>D. Nanda kishore, <sup>2</sup>P. Amrutha

<sup>1</sup>PG scholar, Lecturer, <sup>2</sup>Dept. Of E.E.E

<sup>1,2</sup>Sri Krishnadevaraya University College of Engineering And Technology, Ananthapuram, A.P.

**Abstract**—This paper exhibits an isolated microgrid, with synchronous generator (SG) based diesel generation (DG) framework in combination with solar photo-voltaic (PV). The DG supplies capacity to the heap specifically, and a battery upheld voltage source converter (VSC) is associated in shunt at purpose of regular coupling (PCC). The PV cluster is associated at DC-connection of the VSC through a lift converter. A high order optimization based adaptive filter control scheme is utilized for keeping up the nature of PCC voltages and source currents. This controller makes the waveform free of twisting, expels blunders because of unbalances, rectifies the power factor and makes the source current smooth sinusoidal, regardless of the idea of load. MATLAB/Simulink based reenactment results show palatable execution of the given framework.

**Keywords**—Battery, diesel generator, LMF, power quality, photo-voltaic (PV).

## II. INTRODUCTION:

Renewable energy (RE) is being looked at as a definitive panacea for handling an global warming, changing atmosphere and controlling the proceeded with exhaustion of petroleum products. Henceforth, scientists, government segments and utilities by and large are attempting to incorporate RE frameworks into the power matrix and conveyance systems. In the present situation, the solar energy is the best type of RE as far as its spotless nature, clamor less, non-dirtying and accessible in wealth even in remote areas. A portion of the significant potential difficulties to be confronted when coordinating solar photovoltaic (SPV) framework with the lattice are voltage flimsiness, unwavering quality, feeble matrix framework and corrupted power quality. The SPV framework has turned out to be a bleeding edge innovation in the field of intensity framework as it has been exceptionally compelling in providing power at remote areas where transmission systems can't reach, as it is anything but difficult to introduce, requires low support and has different focal points. In a regular twofold phase topology, first stage includes most extreme power point following and the second stage controls the separated power into the circulation arrange.

Consuming of non-renewable energy sources for delivering power has been a noteworthy reason for a dangerous atmospheric deviation. Therefore, scientists have

been searching for elective sources for power creation, which are supportable and condition agreeable. Also, nations are moving in the direction of influencing their entire vehicle to armada and power creation parts free of consuming petroleum derivatives. This has prompted ascend in renewable based energy frameworks, for example, PV, wind, hydro, biomass, sea warm energy, tidal energy, and so on. Of late, renewable energy based microgrids are ending up progressively mainstream to supply capacity to urban, country or remote territories. Such frameworks can be worked with or without matrix. These sources are enduring and cause no damage to the earth, nonetheless, their variable and fluctuating nature makes the assignment of incorporating them a genuine test. This offers ascend to the need of savvy controllers which can direct the voltage, current and recurrence of the framework if there should arise an occurrence of quality/nonattendance of network or straight/nonlinear load or unbalance in the three-stage frameworks, and henceforth, make the framework more steady, solid and secure.

Diesel engines can be utilized with permanent magnet synchronous generators, enlistment generators or synchronous hesitance generators, and so on.. The best eco-friendliness is gotten in diesel generators when they are worked at 80% to 100% of their evaluated limit. Diesel generators have been source of power for long. In urban territories, they are utilized as a back-up where as in provincial zones, it is one of the essential sources of power. In this way, the PV based microgrids could be made more steady and solid by coordinating them with diesel generators. Numerous creators have taken a shot at such frameworks and proposed controllers for directing voltage, current and power stream. In any case, utilization of energy stockpiling gadgets alongside PV-DG not just aides in lessening rating of DG, it additionally proficiently deals with the homeless people and keeps up the DC-interface voltage.

## II. ADAPTIVE FILTER CONTROL:

Numerous analysts have proposed control quality controllers for miniaturized scale frameworks. Slightest mean square (LMS) is an old method of expelling clamor and bends from the flag. In view of LMS, calculations, for example, hyperbolic digression work based LMS, altered

variable advance filtered-x LMS (FXLMS) based control, and so forth have been introduced in order to accomplish stack leveling, voltage and recurrence control and power quality improvement. LMF is a higher order filter when contrasted with LMS, and in this manner, it has a higher flag to commotion proportion (SNR). The predominance of this control over traditional LMS calculations, as far as mean square blunder (MSE) and dependability, has been presented. This paper exhibits an adaptive filter, in a three-stage DG-PV based isolated miniaturized scale lattice. It evacuates the sounds display in the current because of the nonlinear loads, and makes it smooth sinusoidal, in this way, decreasing the aggregate consonant bending (THD) according to IEEE-519 standard. A lift converter associates PV and DC-connection of VSC, and executes the most extreme power point following (MPPT) for PV cluster. The battery is straightforwardly associated at the DC-connect.

Numerous specialists have proposed control quality controllers for miniaturized scale lattices. Minimum mean square (LMS) is an old strategy of expelling commotion and contortions from the flag. In light of LMS, calculations, for example, hyperbolic digression work based LMS, altered variable advance filtered-x LMS (FXLMS) based control, and so forth have been displayed in order to accomplish stack leveling, voltage and recurrence control and power quality improvement. LMF is a higher order filter when contrasted with LMS, and in this manner, it has a higher flag to commotion proportion (SNR). The predominance of this control over traditional LMS calculations, as far as mean square blunder (MSE) and dependability, has been displayed.

### III. EXISTING SYSTEM:

Existing technique proposed the utilization of a minimum mean fourth (LMF) based calculation for single-organize three-stage lattice incorporated SPV (Solar Photovoltaic) framework. It comprises of SPV exhibit, VSC (Voltage Source Converter), three-stage network and straight/nonlinear burdens. This framework has a SPV cluster combined with a VSC to give three-stage dynamic power and furthermore goes about as a static compensator for the receptive power pay. It additionally complies with an IEEE-519 standard on music by enhancing the nature of intensity in the three-stage dissemination arrange. Accordingly, this framework serves to give music lightening, stack adjusting, control factor remedy (PFC) and

directing the terminal voltage at the PCC (Point of Common Coupling). In order to build the proficiency and greatest capacity to be removed from the SPV cluster at different natural conditions, a solitary stage framework is utilized alongside P&O (Perturb and Observe) strategy for MPPT (Maximum Power Point Tracking) coordinated with the LMF based control system

Adaptive filter hypothesis has shown its potential in following changes in the earth and qualities of the obscure frameworks in which this filter is utilized. With evolving condition, the filter parameters are self-balanced that the conduct of the arrangement of the filter and condition are kept in order to fill its need. The LMF technique is one of the calculations from the group of the adaptive filters. LMF has been first proposed by Wallach and Widrow in 1984 as a change to the LMS (Least Mean Square) calculation. The LMF technique has essentially lesser commotion in the weights than the customary LMS calculation when the time steady qualities for both the strategies are set to be equivalent. The principle objective of this calculation is to give a lessened enduring condition of maladjustment for the expected rate of learning when contrasted with the LMS strategy. It has been seen that the LMS method can't accomplish great enduring state execution in situations having low SNR's (Signal to Noise Ratios) as it works like a lower order adaptive filter. To defeat this issue and to enhance the enduring state execution of the framework, a fourth-order control optimization has been connected which can dispense with clamor impedances even in low SNR locales. Henceforth, the LMF strategy goes about as a higher order adaptive filter in which the refreshing condition includes fourth order power optimization. It has been seen that adaptive calculations like LMF with high order snapshots of blunders perform better MSE (Mean Square Error) than traditional LMS calculations which has been demonstrated. MSE is a parameter which gives a thought regarding the execution of blunder required with the calculation.

### IV. SYSTEM:

#### A. SYSTEM DESIGN AND MODELING

Fig. 1 depicts the configuration of the system. A two stage PV system is supplying power to the nonlinear load, through a VSC. The battery is connected directly at the DC-link. An SG based DG is connected at PCC to provide support power in case of low or absence of insolation.

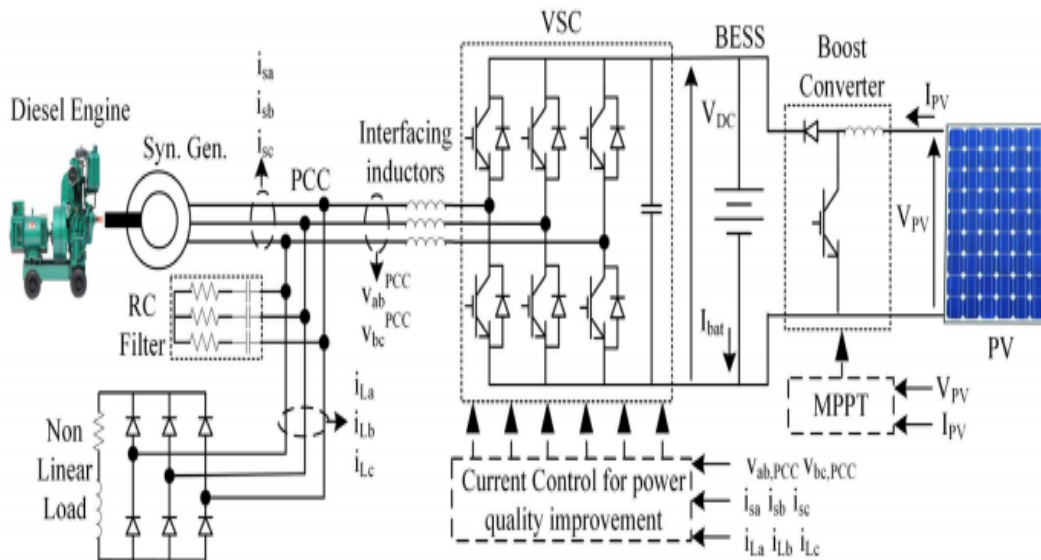

Fig. 1 System model.

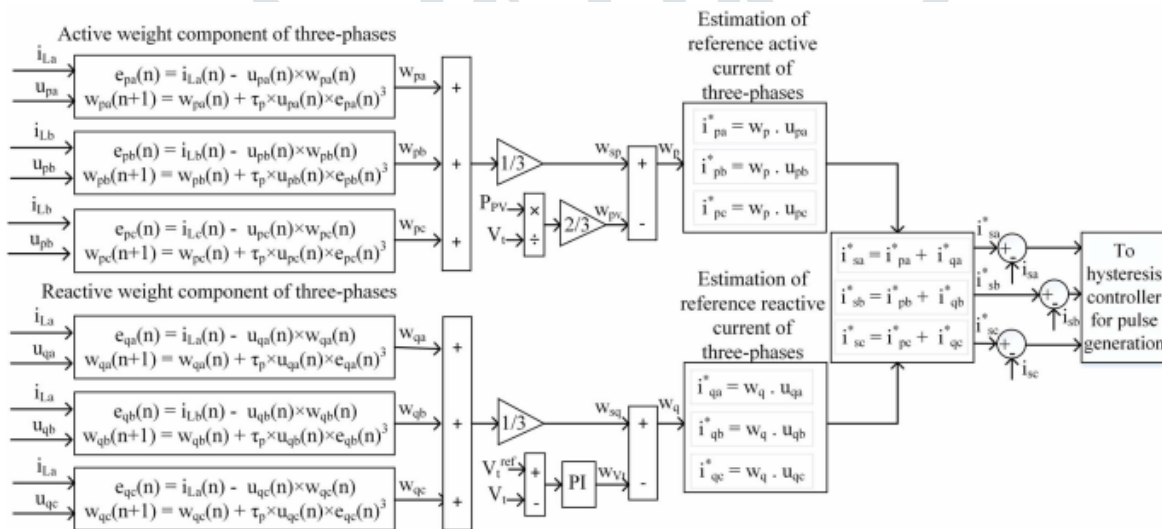

Fig. 2 Adaptive filter for power quality improvement.

**B. VSC CONTROL**

The adaptive control for regulating power quality at PCC through VSC is shown in Fig. 2. It calculates the weight of the active and reactive components of currents and estimates the reference current for each phase, using the in-phase and quadrature unit templates of voltage.

**V. SIMULATION RESULTS**

The proposed micro-grid is simulated in MATLAB/Simulink and the responses for change in load, load unbalance and PV variation are observed.

**A. Steady State Operation**

The steady state response where the load is constant, and is supplied power by both DG and PV, is shown in Fig. 3. The DC side parameters i.e. PV voltage, current and power, DC-link voltage and battery current can be seen in Fig. 3(a). It can be noted that PV is operating in MPPT at

solar insolation of 500W/m<sup>2</sup>. The load and DG side voltage and currents are shown in Fig. 3(b). The internal parameters of the control  $w_p$  and  $e_{pa}$  are also shown in the same figure. The THD in currents and voltage are presented in Table I.

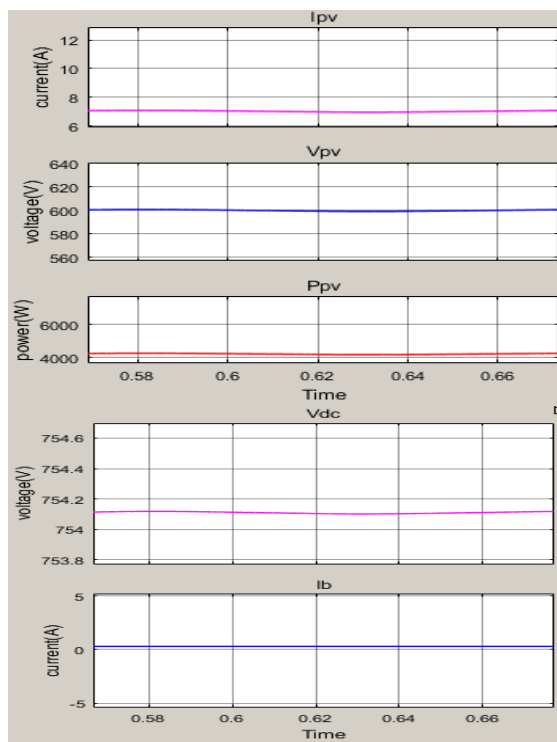

(a)

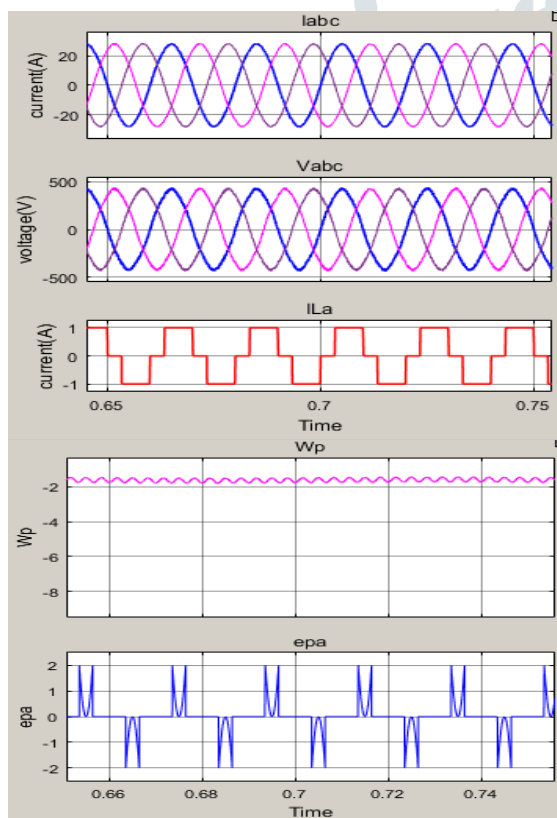

(b)

Fig. 3 Steady State Response of DG-PV micro-grid.

**TABLE I**  
**TOTAL HARMONIC DISTORTIONS**

Parameter	Signal	THD
Load Current	iLa	26.69%
DG Current	isa	2.05%
PCC Voltage	vsab	3.67%

**B. Effect of PV variation**

The response of system to PV insolation change is depicted in Figs. 4(a) and (b). At  $t = 1$  s, insolation rises from  $500\text{W/m}^2$  to  $1000\text{W/m}^2$ , raising the PV power from  $4.2\text{kW}$  to  $8.4\text{kW}$  approximately, as seen in Fig. 4(a). Since the load current is constant, this leads to decrease in the net active weight of the DG current, thus, reducing the current drawn from DG. The same is depicted in Fig. 4(b). The DC-link and AC voltages are maintained constant by battery and VSC

**C. Effect of Demand Variation**

The effect of change in load is demonstrated in Figs. 4(c) and (d). The DC side voltage current and power remain same, as their is no change in the solar insolation. It can be observed from Fig. 4(d), that the reduction in load simply lowers down the current drawn from DG, as the active weight component has been decreased by the VSC controller. The quality of current and voltage are regulated all the time.

**D. Effect of Unbalance**

A single-phase open circuit fault is created in phase-a. The response of system is shown in Figs. 4(e) and (f). As net load has reduced, the source current of each phase is reduced, but it is still maintained balanced and pure sinusoidal by the controller. The system smoothly recovers and quickly reaches normal steady state, with normal DC and AC voltages.



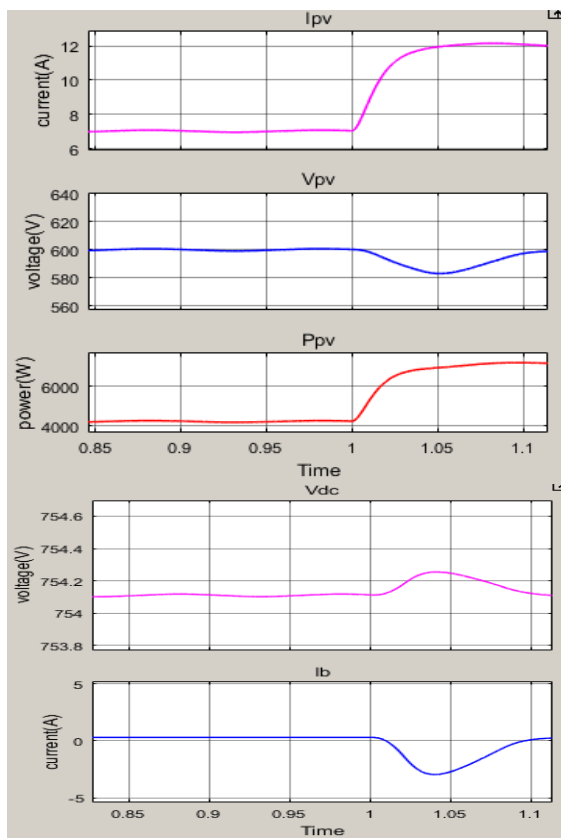

(a)

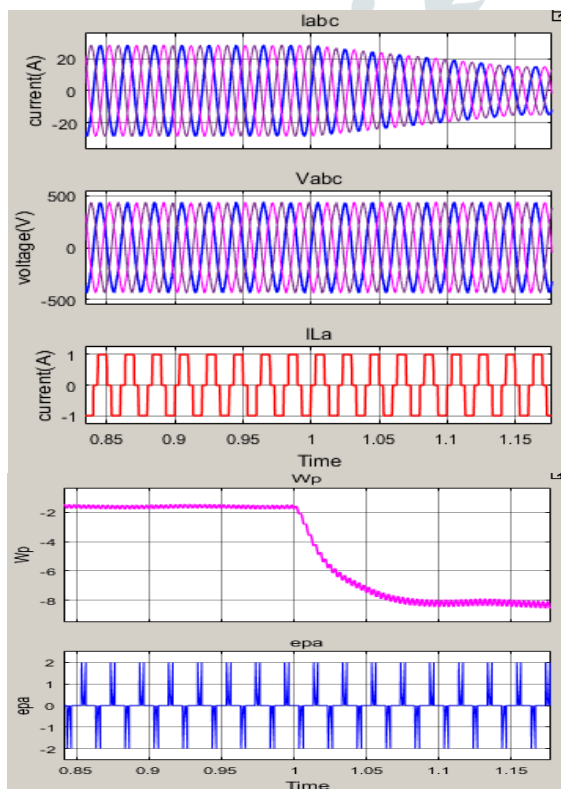

(b)

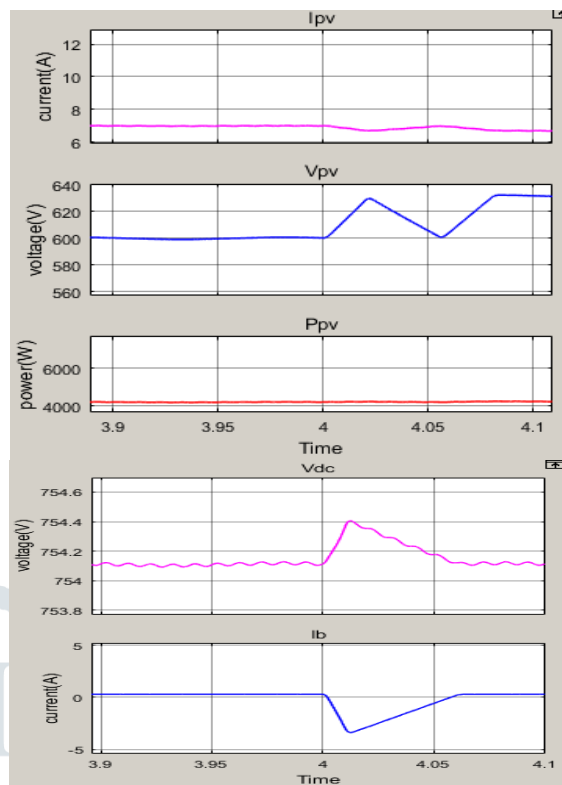

(c)

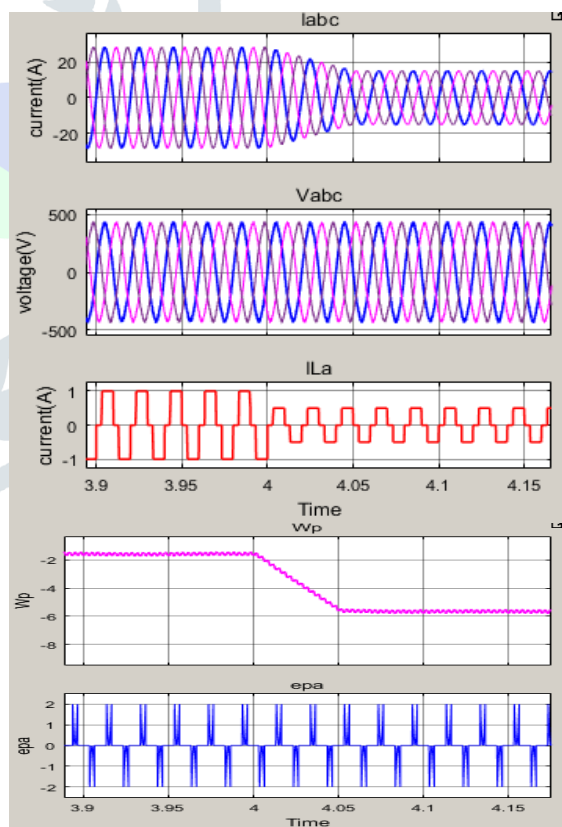

(d)

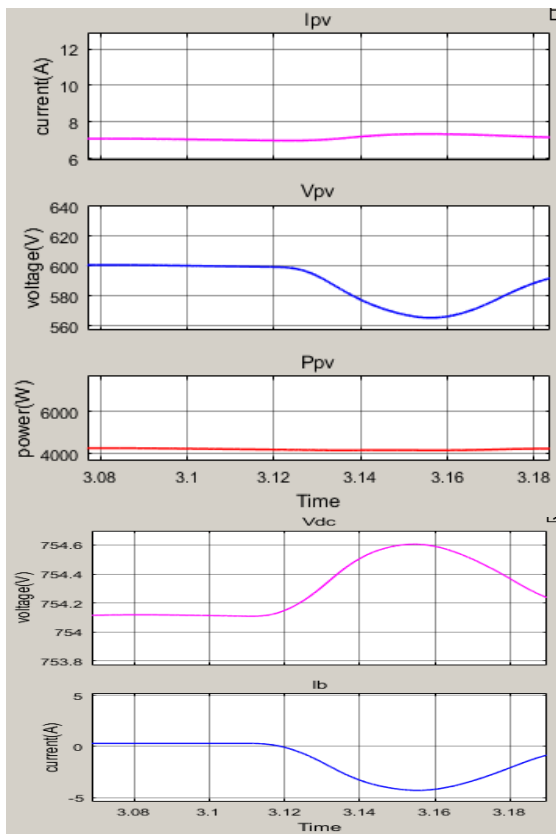

(e)

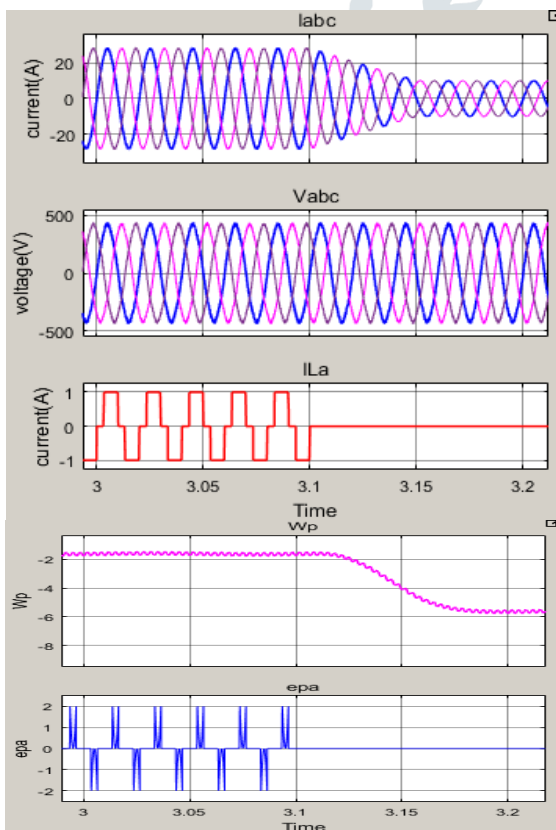

(f)

Fig. 4 Dynamic Response of DG-PV micro-grid

An isolated SG based DG and PV hybrid micro-grid has been presented here, with a battery supported VSC connected at PCC. Three-phase adaptive control is used for power quality improvement through VSC. The given system and control have been simulated in MATLAB/Simulink environment and results demonstrate their satisfactory performance in both steady state and dynamic conditions.

## REFERENCES

- [1] G. Shafiqullah et al., "Meeting energy demand and global warming by integrating renewable energy into the grid," in 22nd Australasian Universities Power Engg. Conf. (AUPEC), pp. 1–7, Bali, 2012.
- [2] M. Milligan et al., "Alternatives No More: Wind and Solar Power Are Mainstays of a Clean, Reliable, Affordable Grid," IEEE Power & Energy Mag., vol. 13, no. 6, pp. 78–87, Nov.-Dec. 2015.
- [3] L. Partain and L. Fraas, "Displacing California's coal and nuclear generation with solar PV and wind by 2022 using vehicle-to-grid energy storage," IEEE Photovoltaic Specialist Conf., pp. 1–6, LA, 2015.
- [4] Daniel E. Olivares et al., "Trends in Microgrid Control," in 2015 IEEE Trans. Smart Grid, vol. 5, no.4, pp. 1905–1919, July, 2014.
- [5] Z. Zavody, "The grid challenges for renewable energy An overview and some priorities," IET Seminar on Integrating Renewable Energy to the Grid, pp. 1–24, London 2014.
- [6] G. Pathak, B. Singh and B. K. Panigrahi, "Permanent magnet synchronous generator based wind energy and DG hybrid system," IEEE Nat. Power Systems Conf. (NPSC), pp. 1–6, Guwahati, 2014.
- [7] G. Pathak, B. Singh and B. K. Panigrahi, "Isolated microgrid employing PMBLDCG for wind power generation and synchronous reluctance generator for DG system," IEEE 6th India Int. Conf. Power Electron. (IICPE), pp. 1–6, Kurukshetra, 2014.
- [8] P. J. Chauhan et al., "Fuel efficiency improvement by optimal scheduling of diesel generators using PSO in offshore support vessel with DC power system architecture," IEEE PES Asia-Pacific Power & Energy Engg. Conf. (APPEEC), Brisbane, QLD, 2015, pp. 1-6.
- [9] S. Mishra, D. Ramasubramanian and P. C. Sekhar, "A Seamless Control Methodology for a Grid Connected and Isolated PV-Diesel Microgrid," IEEE Trans. Power Syst., vol. 28, no. 4, pp. 4393-4404, Nov. 2013.
- [10] M. Datta, T. Senjyu, A. Yona, T. Funabashi and C. H. Kim, "A Coordinated Control Method for Leveling PV Output Power Fluctuations of PVDiesel Hybrid Systems Connected to Isolated Power Utility," IEEE Trans. Energy Convers., vol. 24, no. 1, pp. 153-162, March 2009.
- [11] R. W. Wies, R. A. Johnson, A. N. Agrawal and T. J. Chubb, "Simulink model for economic analysis and environmental impacts of a PV with diesel-battery system for remote villages," IEEE Trans. Power Syst., vol. 20, no. 2, pp. 692-700, May 2005.

## VI. CONCLUSION

- [12] B. Singh, R. Niwas and S. K. Dube, "Load Leveling and Voltage Control of Permanent Magnet Synchronous Generator-Based DG Set for Standalone Supply System," IEEE Trans. Ind. Informat., vol. 10, no. 4, pp. 2034-2043, 2014.
- [13] R. Niwas and B. Singh, "Solid-state control for reactive power compensation and power quality improvement of wound field synchronous generator-based diesel generator sets," IET Electric Power App., vol. 9, no. 6, pp. 397-404, 2015.
- [14] R. K. Agarwal, I. Hussain and B. Singh, "LMF-Based Control Algorithm for Single Stage Three-Phase Grid Integrated Solar PV System," IEEE Trans. Sust. Energy, vol. 7, no. 4, pp. 1379-1387, Oct. 2016.
- [15] J. C. M. Bermudez and V. H. Nascimento, "When is the least-mean fourth algorithm mean-square stable?," Proc. IEEE Int. Conf. Acoust. Speech Sig. Process., vol. 4, pp. iv/341-iv/344, Mar. 18-23, 2005.
- [16] E. Eweda, "Global stabilization of the least mean fourth algorithm," IEEE Trans. Sig. Process., vol. 60, no. 3, pp. 1473-1477, Mar. 2012.
- [17] O. Ibrahim, N. Z. Yahaya, N. Saad and M. W. Umar, "Matlab/Simulink model of solar PV array with perturb and observe MPPT for maximising PV array efficiency," IEEE Conf. Energy Conver. (CENCON), pp. 254- 258, 2015.

#### Authors Profile



Mr.D.Nandakishore currently pursuing his M.tech in Electrical Power systems in Sri krishnaDevaraya University College Of Engineering and Technology,Ananthapuram A.P.He completed his under graduation in 2016 from Audisankara Institute of Technology,Nellore Dist.,A.P.



Mrs.P. Amrutha is Working as a Lecturer in the department of Electrical And Electronics Engineering at Sri KrishnaDevaraya University College Of Engineering and Technology,Ananthapuramu A.P..She completed B.Tech In E.E.E Sree Jnana Mrugurajendra Institute Of Technology,Kuvempu University in the year 2000 and M.Tech In Power Systems JNTU Kakinada in the year 2011, and pursuing PhD in JNTU,ananthapuramu. And Has Over 14 Years Of Teaching Experience.Her areas of interest Electrical Circuits , Facts ,Power Systems,Control Systems.