

Optimized Multi Class Classification of Images Using Deep Learning

¹Mr. Utpal Shrivastava, ²Dr. Vikas Thada

¹Assistant Professor, ²Associate Professor

Department of Computer Science & Engineering

Amity School of Engineering & Technology

Amity University Gurgaon

Abstract: Deep learning is rapidly growing field for classification of digital images. Convolution Neural network(CNN) has become the de-facto standard for image classification which is subfield of deep learning. The paper look at optimizing the classification of images using CNN and various deep learning optimization algorithms. The dataset comprises three different classes of images: Rock, Paper and Scissor. Various deep learning optimization algorithm such as stochastic gradient descent, ADAM, RMSProp, Adamax, Adadelta have been tried with varying number of epochs and most optimized one is chosen for predicting unseen images. Optimization algorithm look at the internal parameters of the network such as learning rate, weights, number of neurons etc. To improve and updates the internal parameters of neural network, different optimization methods are used. The framework used is Keras with tensorflow as backend.

Keywords: *deep learning, convolution, optimization, pooling, image classification*

1. INTRODUCTION

Image classification is a task to classify images into specific categories or assigning a label to image as to which class they belong. Deep learning is emerging as fast and accurate method for classification of images of varying size and length. Convolution neural network is a preferred choice for image classification as compare to regular deep neural network very less number of parameters are used[2,3]

The artificial neural network(ANN) mimic the biological model of human brain where different neurons connected together performs some computations and pass the results to next layer of neurons. The neuron is a computational unit in ANN[8,12]. The output of a neuron is calculated using activation function that sums all input coming to that neuron and fires using activation function. Some of the examples of activation function are: ReLu, sigmoid, tanh, leaky ReLu and softmax (for multiclass classification). The CNN consists of varying number of convolutions and each convolution can have convolution layer, Max pooling and flatten layers. The last one must be flatten layer followed by softmax function. Full details of CNN are beyond the scope of this paper.

In this researchwork we have multilayer CNN for image classification using Keras and tensorflow over 3 class of images and have applied different number of optimization algorithm.

2. PROBLEM STATEMENT & DATA SET

The objective of the research work is to design and develop a deep learning model for multi class classification of images using Keras and Tensorflow with improved accuracy for unseen images. The data set chosen was [1] that consists of 3 categories of images: Rock, Paper and Scissors. Each category has 840 training images and 124 testing images. Thus total number of training images are 2520 and 372 testing images. Each image is of dimension(150,150,3). Less number of images sometimes does not give good results. To overcome this concept of imagedatagenerator has been used where in every epoch on the fly images are generated.

generated using image augmentation (rotation, flipping, scaling etc) and are not stored in memory.

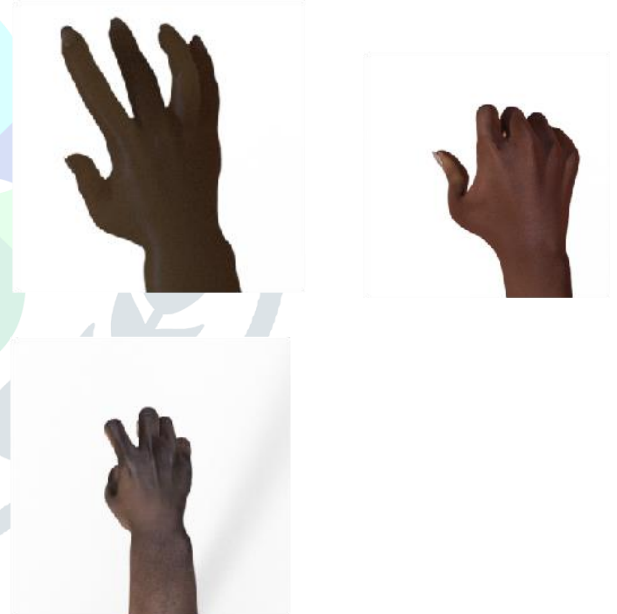
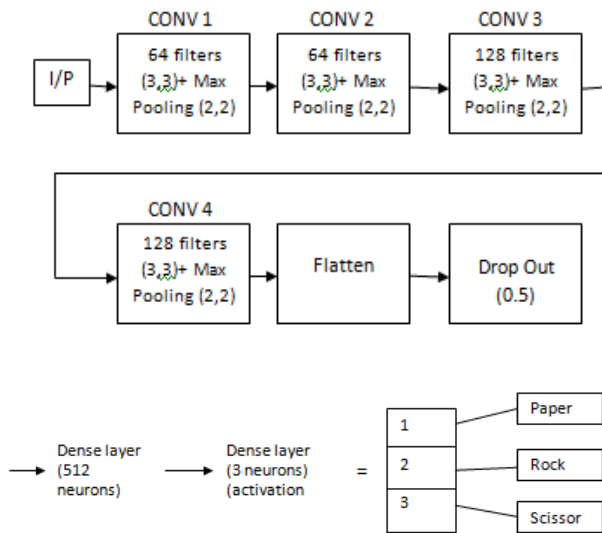

Fig 1: From L to R: paper, rock, scissor

3. DEEP LEARNING MODEL & IMPLEMENTATION

The model used in the research work is shown in the figure 2. The model used 4 different convolutions with varying/same filters of size (3,3) with Maxpooling of size (2,2). After the fourth layer flatten layer is used followed by dropout layer with dropout percentage of 50. The dropout is a regularization technique which prevents overfitting. Following dropout two dense layers are used and in last layer 3 neurons are used as we have 3 different classes for classification. Activation function in last layer is softmax which is standard activation function used for multiclass classification.



The complete code was written in python 3, Keras and tensorflow framework and executed on Google Colab [7] using free GPU runtime. The results are discussed in the next section.

4. RESULTS

The developed model was compiled and run for varying number of epochs (5,10,15,20,25) with different optimizers :rmsprop, adam, adagrad, adamax and sgd (stochastic gradient descent) . The training accuracy and validation accuracy was noted and is shown in table 1:

Fig 2: The Developed Convolution Neural Network model

Table 1: (Training Accuracy, Validation Accuracy) for Various Optimizers

Epoch	Adam	Rmsprop	Adamax	Sgd	Adagrad
5	(0.951, 0.957)	(0.900,0.989)	(0.854,0.887)	(0.430,0.336)	(0.33,0.33)
10	(0.959, .986)	(0.950,0.973)	(0.958,0.975)	(0.60,0.607)	(0.33,0.33)
15	(0.977,0.983)	(0.33,0.33)	(0.969,1.00)	(0.690,0.897)	(0.33,0.33)
20	(0.980,0.981)	(0.963,0.973)	(0.973,0.9812)	(0.807,0.905)	(0.33,0.33)
25	(0.979,1.00)	(0.977,0.9780)	(0.979,0.959)	(0.855,0.897)	(0.33,0.33)

A graph for training vs validation accuracy for all the optimizers is shown below:

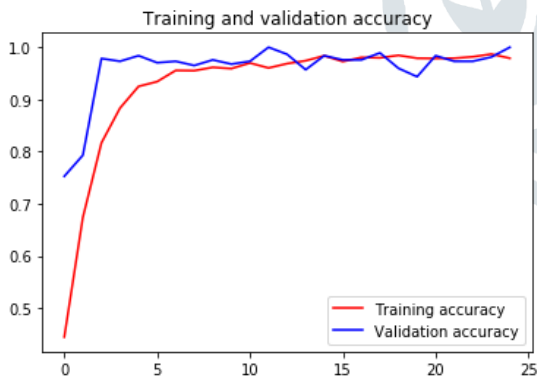

(a) Adam optimizer

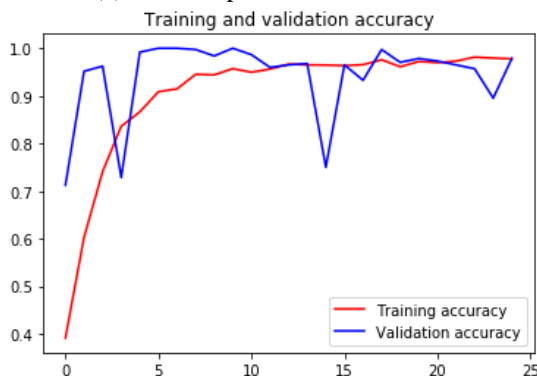

(b) Rmsprop optimizer

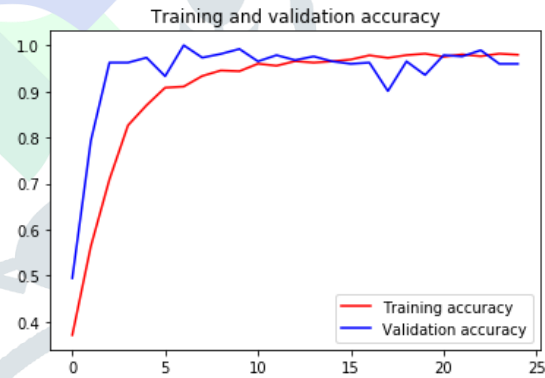

(c) Adamax optimizer

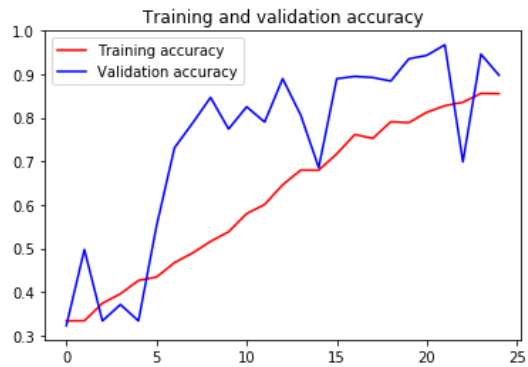

(d) Sgd optimizer

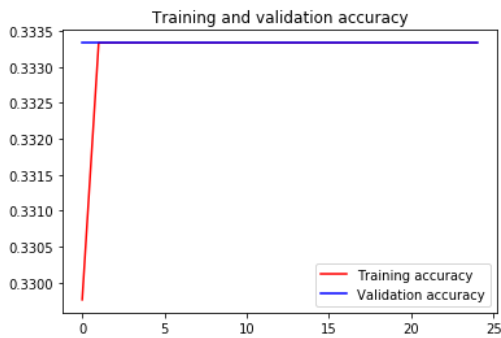

(e) Adagrad optimizer

As can be seen from the graphs above Adamax and Adam are good option for selection of a suitable optimizer. Large spikes in validation accuracy for Sgd and Rmsprop are due to overfitting though research work have used dropout as regularization technique.

5. CONCLUSION

The research work has performed multiclass classification of images using convolution neural network with Keras and Tensorflow framework. Four different convolution layers of different filters and max pooling were used. These layers were followed by flatten and dense layers. For preventing overfitting dropout regularization technique were used. The model developed was executed with different optimizers and tested with plenty of unseen images of rock, scissor and paper. The testing accuracy in this case was turned out to be 100%. The future work lies in trying different values of dropout for overcoming overfitting and getting more data.

References

- [1] <https://storage.googleapis.com/laurencemoroney-blog.appspot.com/rps.zip>
- [2] Xuedam Du, Yinghao Cai, Wang, and Leijie Zhang " Overview of Deep Learning" 31st Youth Academic Annual Conference of Chinese Association of Automation Wuhan China November 11-13-2016.
- [3] Siddhartha Sankar Nath, Janinyaseni Kar, Girish Mishra, Sayan Chakraborty, Nilanjan Dey " A Survey of Image Classification Methods and Techniques "ICCCICT 2014.
- [4] A. Krizhevsky, I. Sutskever, and G. E. Hinton. "ImageNet Classification with Deep Convolutional Neural Networks". Neural Information Processing Systems, Nevada, 2012
- [5] Henrik Petersson, David Gustafsson and David Bergstrom " Hyperspectral Image Analysis using Deep Learning- a Review" IEEE 2016.
- [6] Adrian Carrio, Carlos Sampedro, Alejandro Rodriguez Ramos and Pascual Campoy "A Review of Deep Learning Methods and Applications for unmanned Aerial Vehicles "Hindawi Journal of Sensors 2017.
- [7] <https://colab.research.google.com>
- [8] Walaa Hussein Ibrahim, Ahmed AbdelRhman Ahmed Osman, Yusra Ibrahim Mohamad" MRI Image Classification Using Neural Network" ICCEEE, 2013.
- [9] S. Kim, B. Park, B. S. Song, and S. Yang, " Deep belief network based statistical feature learning for fingerprint liveness detection, " Pattern Recog. Lett., vol 77, pp. 58-65, 2016.
- [10] Gang Liu, Liang Xiao, Caiquan Xiong " Image Classification with deep belief network and improved gradient descent" IEEE 2017.
- [11] Y. Lecun, L. Bottou, Y. Bengio, and P. Haffner, "Gradientbased learning applied to document recognition," Proceedings of the IEEE, vol. 86, no. 11, pp. 2278-2324, 1998.
- [12] Travis Williams, Robert Li " Advanced Image Classification using Wavelets and Convolution Neural Network" IEEE 2016.
- [13] Narek Abroyan, " Convolutional and Recurrent Neural Network for real time data classification" The Seventh International Conference on Innovative Computing Technology (INTECH 2017).
- [14] Ian Goodfellow, Yoshua Bengio, and Aaron Courville, "Deep Learning", Book in preparation for MIT Press, 2016, on-line version available at <http://www.deeplearningbook.org>.
- [15] Michael A. Nielsen, "Neural Networks and Deep Learning", Determination Press, 2015.
- [16] Marek Dabrowski, Justyna Gromada, Tomasz Michalik Orange Centrum "A Practical study of neural network-based image classification model trained with transfer learning method" FedCSIS 2016.
- [17] C. Lu and X. Tang, "Surpassing human-level face verification performance on lfw with gaussianface," arXiv preprint arXiv:1404.3840, 2014.
- [18] L. Deng and D. Yu, "Deep learning: methods and applications," Foundations and Trends in Signal Processing, vol. 7, no. 3-4, pp. 197-387, 2013.
- [19] J. A. Hertz, "Introduction to the theory of neural computation." Boulder, USA: Westview Press, 1991.
- [20] J. Suykens and J. Vandewalle, "Least squares support vector machine classifiers," Neural Processing Letters, vol. 9, no. 3, pp. 293-300, 1999.
- [21] Y. Xiong and R. Zuo, " Recognition of geochemical anomalies using a deep autoencoder network," Computer Geosci-UK, vol. 86, pp. 75-82, 2016.
- [22] Zejian Shi, Minyong Shi, Chunfang Li, " The prediction of character based on recurrent neural network," IEEE computer society, Wuhan China, 2017
- [23] Taro Ishitaki, Ryolchiro Obukata, Tetsuya Oda, Leonard Baroll, "Application of deep recurrent neural network for prediction of user behaviour in Tor Network," 31st International Conference on Advanced Information Networking and Application Workshops, 2017.
- [24] Marek Daabrowski, J. Gromada, T. Michalik, " P practical study of neural network-based image classification model trained with transfer learning method," Federated Conference on Computer Science and Information Systems pp. 49-56, 2016.
- [25] B. Wang, K. Yager, D. Yu, Minh Hoai, " X-ray Scattering image classification using deep learning," IEEE Winter Conference on Application of Computer Science, 2017
- [26] Nur Anis Mohmon and Norsuzilayacob, " A review on classification of satellite image using artificial neural network (ANN)," IEEE 5th Control and System Graduate Research Colloquium, 2014.
- [27] R. Jyothi, Y. K. Sundara Krishna, V. Srinivasa Rao, " Paper Currency recognition for color images based on Artificial Neural Network," International Conference on Electrical, Electronics and Optimization Techniques (ICEEOT), 2016.
- [28] M. Abadi, A. Agarwal, p. Barham, E. Brevdo, Z. f. Chen, C. Citro, et al., " Tensorflow : Large-scale machine learning on heterogeneous distributed systems," arXiv preprint arXiv: 1603.04467, 2016.
- [29] R. Collobert, S. Bengio, and J. Mariethoz, " Torch: a modular machine learning software library," Idiap, No. EPFL-REPORT-82802, 2002.
- [30] R. AI-Rfou, G. Alain, A. Almahairi et al., " Theano ; a python framework for fast computation of mathematics expression," arXiv preprint arXiv : 1605.02688, 2016.
- [31] LeCun, Y., C. Cortes, and C. J. Burges, MNIST handwritten digit database. AT&T Labs [Online]. Available: <http://yann.lecun.com/exdb/mnist>, 2010.