

Improvement in strength of EECO vehicle bumper using reinforcement of natural composite material

¹Pratik Sopan Dhamale, ²Dr.K.D.Devade

¹ PG Student, ² Head of Department,

¹Department of Mechanical Engineering,

¹ D Y Patil Institute of Engineering and Technology, Ambi,

Savitribai Phule Pune University, India.

Abstract : Car bumper is basic segment of a car vehicle which is intended to forestall or lessen physical harm to the front or backsides of traveler engine vehicles by engrossing the effect vitality and dispersing the stress perpendicular to the bearing of impact. An all-around planned vehicle bumper must give wellbeing to occupant and fundamental components of the vehicle and ought to have a low weight. The point of this exploration is to improve the exhibition of frontal bumper by upgrading the auxiliary parameter utilizing static investigation utilizing ANSYS software. Design of existing front bumper in CATIA software as well as analysis of composite material layup in ANSYS ACP tool post to study the effect on existing material, jute epoxy and bamboo fiber composite material layer by layer stress concentration effect and determination of force reaction for specified displacement. It is proposed to manufacture the optimum reinforcement of jute or bamboo fiber epoxy on existing material. It is proposed to fabricate the optimum reinforcement of jute or bamboo fiber epoxy on existing material. The cautious structure and investigation of composite material parameters are done so as to upgrade the quality.

Keywords -FEA, Static analysis, ACP tool, Jute epoxy.

I. INTRODUCTION

One of conceivable application zones that permit material substitution to accomplish lightweight vehicle is front bumper. Advancement of vehicle bumper subsystem, especially bumper beam, can improve weight decrease as well as auxiliary vitality ingestion to satisfy person on foot security guidelines. Various scientists have actualized various kinds of composite materials, namely carbon fiber strengthened plastic (CFRP), glass fiber reinforced plastic (GFRP), sheet forming compound (SMC), and glass mat thermoplastic (GMT) for bumper beam to improve the bumper subsystem execution as it can offer lightweight just as diminish the vitality utilization. Other bumper segments, for example, belt and vitality safe bumpers are made of polypropylene that is a recyclable thermoplastic material.(2) As a plan idea, the straightforward replacement of the material for the bumper beam that is one of the major auxiliary pieces of the bumper subsystem, can adjust the presentation of bumper subsystem during collision condition. The balance crash test is expected to recreate an impact between two comparable measured vehicles with comparative impact attributes. In the counterbalance crash test according to ECER-94 guideline the vehicle going at 56 Km/h impacts with crushable aluminum honeycomb boundary. The obstruction at first reaches 40% of the width of the front of the vehicle on the driver's side. The subsequent high size accident load puts serious requests on the structure of the vehicle and injury to tenants, especially on the driver side (6). An advanced crashworthy vehicle structure is what can ingest the accident vitality by controlled vehicle misshapeness while keeping up satisfactory space with the goal that the lingering crash vitality can be overseen by the restriction frameworks to limit crash loads move to the vehicle inhabitants. Vehicle crashworthiness and tenant wellbeing stay among the most significant and testing plan contemplations in the car business. Car architects endeavor to plan the vehicle structures which limit the measure of injury causing crash vitality that arrives at the tenants. This is practiced by creating auxiliary zones that retain crash vitality outside the traveler compartment - these are designated "squash zones" and they breakdown in an endorsed path at determined burdens, in this manner giving the fitting vitality assimilation and deceleration of the traveler compartment. Hence, front of the vehicle structure should be appropriately planned with the goal that it can assimilate the accident vitality essentially to such an extent that the accident load move to the inhabitant lodge is least.

Braga, R. A et al. In this paper it presents the utilization of jute fiber adhered with polyester resin in the car business in the creation of a back bumper of incubate vehicle. The shaped part acquired great visual attributes, great geometric development and surface without air pockets and defects in the fiber and resin composite. The scientific model to disappointment standard indicated that the back bumper in jute fiber won't avoid to an effect proportionate at 4.0 km/h. Mass = 7.956 kg and medium thickness = 5.0 mm. Determined composite flexibility module toward A path was 1134.0 MPa. Research facility tests results indicated $E_c = 1096.8$ MPa, in another words, 96.7 % of the determined worth. The jute will be 166.7 MPa and the is 28.79 MPa. At that point the rear bumper will break with the genuine effect at 4 km/h. so, multiplying the thickness of the back bumper of jute fiber, strain rigidity moves to 117.8 MPa, this isn't adequate to help a frontal effect of 4 km/h.(1)

Giovanni Belingardi et al. In this paper it speaks to the instance of car front and back bumper. Along these lines, it is prescribed to create cost effective plan procedure and investigation utilizing existing limited component strategies so as to assess the presentation of various the structure arrangements under different stacking, material and natural conditions, since from the most punctual phases of the structure movement. Significant limitations that have been managed, are bumper crash obstruction and firmness with specific reference to the current person on foot security standard. In this investigation three unique materials – in particular steel, GMT and CFRP (with three overlay types) - have been assessed for the bumper transverse bar, to comprehend the impact of material substitution on crash conduct of vehicle during low-speed frontal accident test performed by numerical reproduction with the ABAQUS code, as indicated by the standard NHTSA impact tests. At the point when the material substitution of bumper beam is done under equivalent sheet thickness, CFRP improve the crashworthiness and lessen the weigh by 6.53 kg (to 18% of the first weight). At the point when the material substitution of bumper bar is done under the equivalent bowing firmness models, GMT arrangement displays better crashworthiness by retaining more vitality than steel and CFRP arrangements. For this situation up to 46.4% gauge decrease of the bumper beam can be accomplished with GMT.(2)

P. Ragupathi et al. In this paper it looks at the effect quality, cost and weight of jute-based composite bumper with that of the current steel bumper. The jute composite bumper was created by applying a progression of jute fiber layers and liquid resin layers. Charpy impact test was completed to discover the effect quality of 2 composite bumper which was seen to be 7.14 J/mm. When contrasted and the steel bumper, the composite bumper is 58% less in cost and a weight decrease of 56.1% is accomplished. The effect quality of jute fiber composite bumper is 2 3.89 J/mm more than that of the steel bumper of a similar size, i.e., 54.5% expansion for jute fiber composite bumper. The weight and cost of the jute fiber composite bumper were seen as diminished by 56.1% and 58%, individually in correlation with the steel bumper. Since the effect quality of the jute fiber composite bumper is far more prominent than that of the steel bumper with the upside of diminished weight and cost, the discoveries of this investigation can be applied to car applications.(3)

Tie Wang et al. In this paper it propose the most significant piece of the car front bumper framework, to be specific, the bumper beam, is concentrated by changing the material and thickness to improve the crashworthiness execution in low-speed impact. To begin with, the bumper bar examination is cultivated for carbon fiber composite and steel material to dissect their distortion, weight, impact strength, vitality assimilation, and the speeding up of the impactor. As an outcome, the bumper beam made via carbon fiber composite accomplishes better effect conduct. Second, on the motivation behind lightweight, the bumper light emissions thickness including 5.4, 6, 6.6, and 7.2mm are explored. From the outset, it can ensure the bumper, radiator, motor hood, and lights when low-speed sway occurs between the car and different autos or obstructions and move the effect vitality to different segments of the car when rapid effect happens. Second, it ought to limit the injury of the people on foot while the vehicle hits walkers. Third, it might satisfy the vehicle body streamlined prerequisites. At long last, it can finish and embellish the vehicle body. Contrasting and utilizing the steel bumper beam, less bumper beam twisting, sway power among impactor and belt, and speeding up of impactor can be picked up by the carbon fiber composite bumper bar. Through breaking down the effect conduct of various thickness bumper beams, the best decision of thickness is 5.4mm. Its weight is 2.32kg. Its weight decrease proportion is up to 53.2% than the steel bumper beam without giving up the effect execution.(4)

Nikola Schmid ova et al., In this paper it centers around the potential outcomes of adjusting the power and vitality reaction of the composite beam when utilized as an auto collision safeguard. It was indicated that the effect power and vitality retention of the tried composite beam can be viably affected. It is resolved essentially by the capacity to secure travelers if there should be an occurrence of unavoidable mishaps. It is given by the capacity of the structure (body) to retain the motor vitality of the effect by transformation to potential vitality during its twisting as well as harm. In present plans this capacity is given by the structure of the structure (shape and decision of material. The impact of the size of the harm on the variety of the power during sway was likewise researched. It was seen that littler gaps affect the variety of the power than greater openings. The lessening of the normal power after effect was watched likewise in examples AI20CH, however the sinusoidal conduct of the extent of the power isn't helpful. Half-gaps as initiators for diminishing the pinnacle sway power, as opposed to chamfers, didn't end up being effective during the dynamic tests.(5)

1.1 Problem Statement

There are two various types of effects, that is, flexible effect and plastic effect. The sort of effect which happens between the front guard and a hindrance in this article is versatile plastic effect on the grounds that the serious accident power exists. To analysis of lightweight materials, the jute and bamboo fiber composite is selected as the material of the reinforcement on exiting bumper of stainless steel in order to achieve the improvement in impact energy.

1.2 Objective

- Modelling of existing frontal bumper of a four-wheeler in CATIA V5 software.
- To determine reaction force for existing stainless-steel material, jute epoxy reinforced and bamboo fiber epoxy reinforced to obtain maximum force carrying model in ANSYS software by static structural analysis.
- To perform layer by layer arrangement using ANSYS ACP tool post.
- To manufacture of composite material frontal car bumper using Hand lay method for reinforcement of composite layer.
- To perform experimental testing of existing and optimized model of frontal bumper using UTM.
- Experimental testing and correlating results.

1.3 Methodology

Step 1: - Initially research paper are studied to find out research gap for project then necessary parameters are studied in detail. After going through these papers, we learnt about reinforcement of composite material car bumper.

Step2: - Research gap is studied to understand new objectives for project.

Step 3:- After deciding the components, the 3D Model and drafting will be done with the help of CATIA software.

Step 4:- The static structural analysis of the components will be performed with the help of ANSYS ACP tool post.

Step 5:- The Experimental Testing will be carried out using UTM.

Step 6:- Comparative analysis between the experimental and analysis result.

II. CAD MODEL AND FEA ANALYSIS

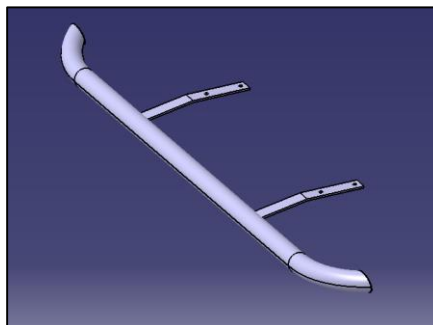

Fig. 1 CATIA model of bumper

In the project we are selecting the EECO Vehicle Bumper. The 3D CAD Model Drawn in the CATIA software show in the figure 1. The Model Reference taken by the existing EECO vehicle bumper and physical dimension taken and drawn the CAD model in CATIA software.

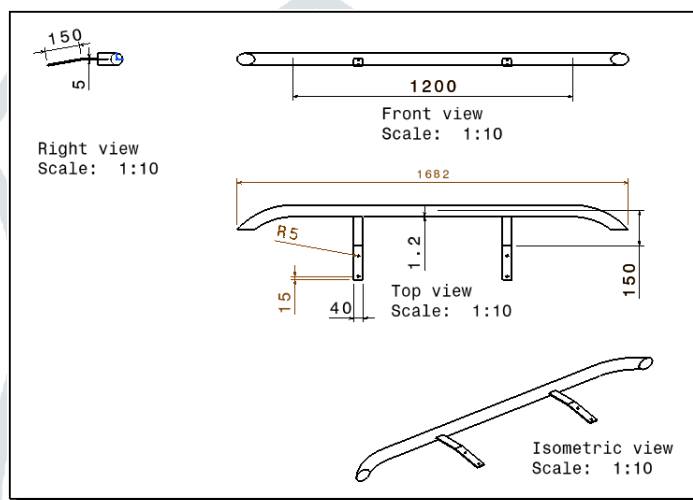

Fig. 2 drafting of bumper

The figure 1 show that 3D CAD model of front bumper after completing the 3D model we moved for the drafting of the component. The drafting of the component are show in the figure 2 and providing the dimension of the component.

2.1 Finite Element Analysis (FEA)

Figure 3 show that the geometry import in the ANSYS

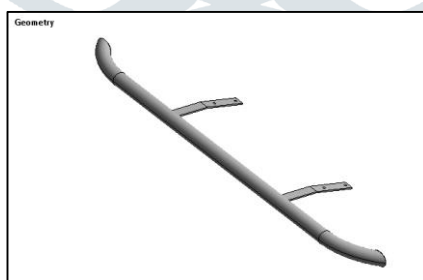

Fig.3 geometry imported in ANSYS

Table 1 material properties of stainless steel

Properties of Outline Row 3: Stainless Steel			
	A	B	C
1	Property	Value	Unit
2	Material Field Variables	Table	
3	Density	7750	kg m ⁻³
4	Isotropic Secant Coefficient of Thermal Expansion		
6	Isotropic Elasticity		
7	Derive from	Young's Modulus and Poiss...	
8	Young's Modulus	1.93E+11	Pa
9	Poisson's Ratio	0.31	
10	Bulk Modulus	1.693E+11	Pa
11	Shear Modulus	7.3664E+10	Pa

2.2 Mesh

In ANSYS meshing is performed as similar to discretization process in FEA procedure in which it breaks whole components in small elements and nodes. So, in analysis boundary condition equation are solved at these elements and nodes. ANSYS Meshing may be all-purpose, intelligent, automated high-performance product. It produces the foremost acceptable mesh for correct,

economical metaphysics solutions. A mesh well matched for a selected analysis may be generated with one click for all elements in a very model.

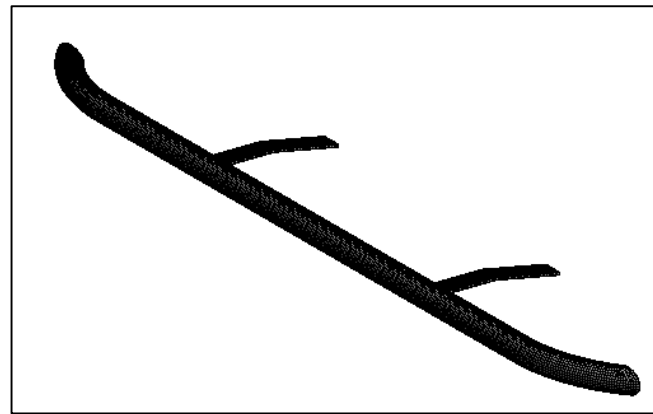

Statistics	
<input type="checkbox"/> Nodes	13016
<input type="checkbox"/> Elements	13000

Fig.4 details of meshing

2.3 Boundary Conditions

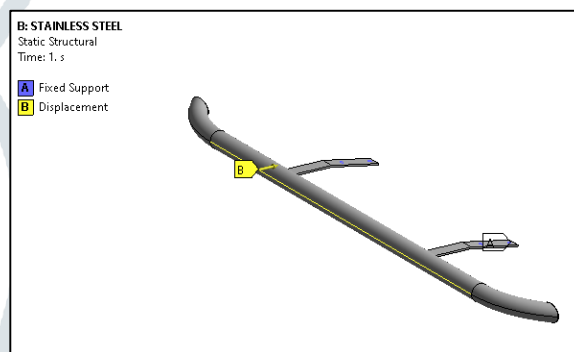

Fig.5 boundary condition

Fixed support is applied at bolt mounting location and displacement of 1 mm is applied to determine force reaction. Show in Figure 5.

2.4 FEA Stainless-Steel

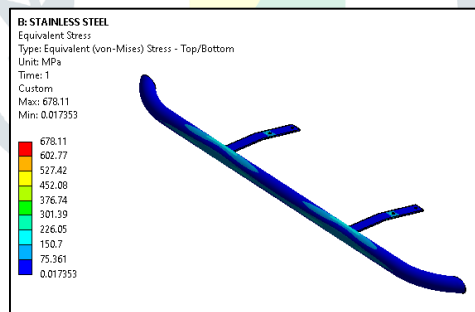
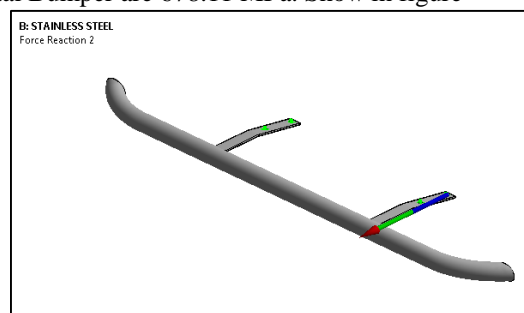

Fig.6 equivalent stress results of steel

Equivalent stress in Stainless-steel frontal Bumper are 678.11 MPa. Show in figure



Maximum Value Over Time	
<input type="checkbox"/> X Axis	-5.5112e-002 N
<input type="checkbox"/> Y Axis	-725.71 N
<input type="checkbox"/> Z Axis	52.509 N
<input type="checkbox"/> Total	6942.7 N

Fig.7 force reaction results of steel

The Reaction Forces of Stainless steel is 6942.7 MPa for the 1mm of the displacement. Show in figure 7.

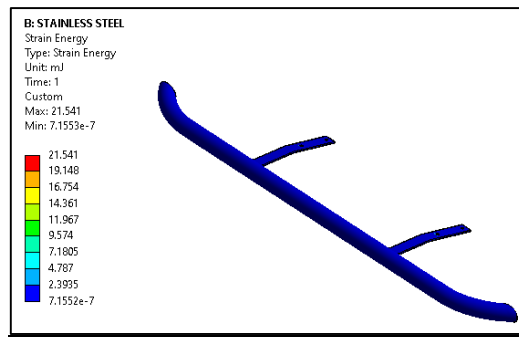

Fig.8 Strain energy result of steel

Strain Energy of the stainless-steel is 21.54 MPa. Show in figure 8.

2.5 Jute Epoxy Reinforcement

Table 2 material properties of Jute

Properties of Outline Row 3: JUTE			
	A	B	C
1	Property	Value	Unit
2	Material Field Variables	Table	
3	Density	1.33	kg m ⁻³
4	Isotropic Elasticity		
5	Derive from	Young's Modulus and Poiss...	
6	Young's Modulus	26500	MPa
7	Poisson's Ratio	0.35	
8	Bulk Modulus	2.9444E+10	Pa
9	Shear Modulus	9.8148E+09	Pa

In existing stainless-steel bumper reinforcement of jute epoxy of 2 mm is applied on surface. To enhance the existing force reaction following ANSYS ACP tool post is used.

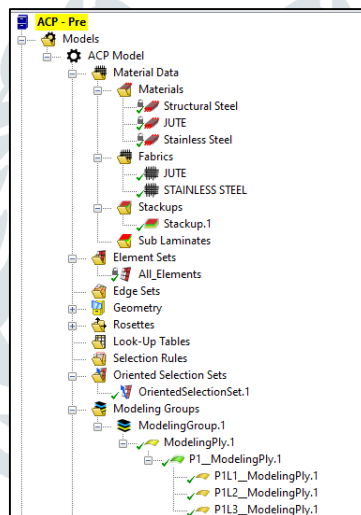

Fig.9 ACP tool post layout

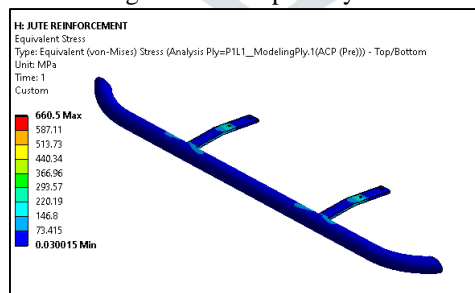

Fig.10 equivalent stress at layer 1of jute

Equivalent stress of Jute Reinforcement in 1 layer is 660.5 MPa. Show in figure 10.

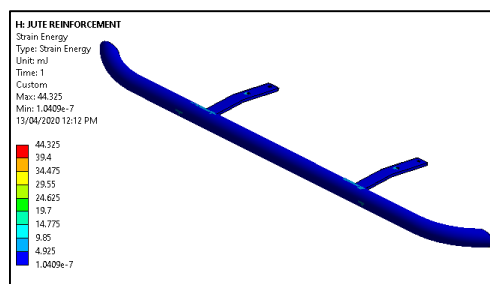

Fig.11 Strain energy result of jute

Strain energy results of Jute Reinforcement is 44.325 MPa. Show in figure 11

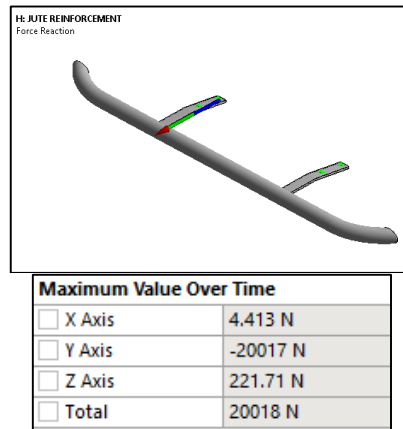

Fig. 12 Force reaction result of jute

Force reaction results of Jute Reinforcement is 20018 MPA. Show in figure 12. Jute has the maximum force reaction compared to the existing material steel.

2.6 Bamboo Fiber Reinforcement

Table.3 Material properties of bamboo fiber reinforcement

Properties of Outline Row 3: BAMBOO		
A	B	C
Property	Value	Unit
Material Field Variables	Table	
Density	0.85	kg m ⁻³
Isotropic Elasticity		
Derive from	Young's Modulus and Pois...	
Young's Modulus	21500	Pa
Poisson's Ratio	0.35	
Bulk Modulus	23089	Pa
Shear Modulus	7963	Pa

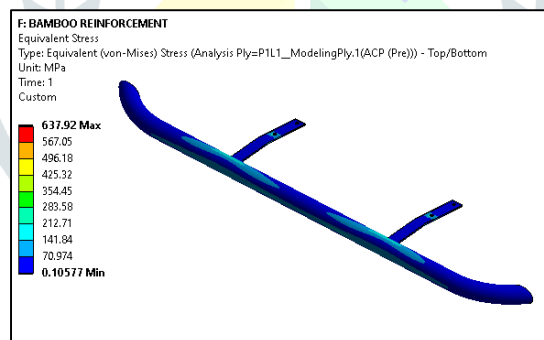

Fig.13 equivalent stress result at layer 1

Equivalent stress results of Bamboo Reinforcement in 1 layer is 637.92MPa. Show in figure 13.

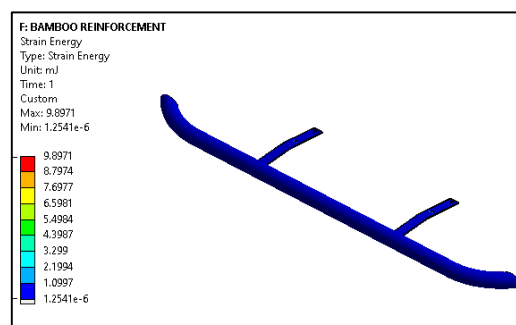

Fig. 14 strain energy results of bamboo

Strain energy results of Bamboo Fiber Reinforcement is 9.89 MPA. Show in figure 14. Bamboo has the less strain energy compared to the Jute and Existing material Steel.

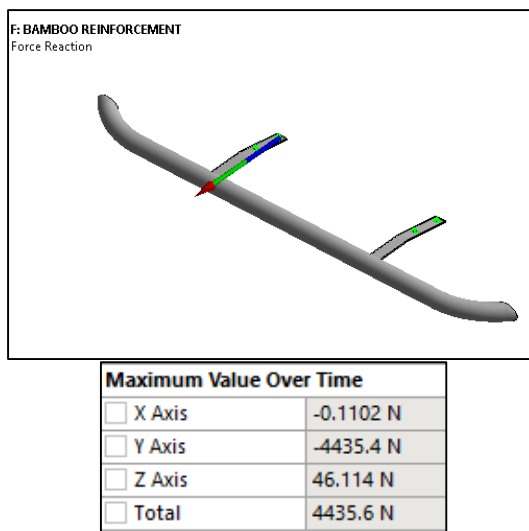

Fig.15 Force reaction result

Force reaction results of Bamboo Fiber Reinforcement is 4435.6 MPa is Show in figure 15.By the Analysis of the total reaction forces Jute has the maximum reaction forces so Jute material is selected for the fabrication of the Reinforcement of steel.

III. EXPERIMENTAL SETUP

A universal testing machine , also known as a universal tester, materials testing machine or materials test frame, is used to test tensile and compressive strength of materials. The tensile testing machine is a tensometer. The "universal" part of the name reflects that it can perform many standard tensile and compression tests on materials, components, and structures (in other words, that it is versatile). The set-up and usage are detailed in a test method, often published by a standards organization. This specifies the sample preparation, fixturing, gauge length (the length which is under study or observation), analysis, etc.The specimen is placed in the machine between the grips and an extensometer if required can automatically record the change in gauge length during the test. If an extensometer is not fitted, the machine itself can record the displacement between its cross heads on which the specimen is held. However, this method not only records the change in length of the specimen but also all other extending / elastic components of the testing machine and its drive systems including any slipping of the specimen in the grips.Once the machine is started it begins to apply an increasing load on specimen. Throughout the tests the control system and its associated software record the load and extension or compression of the specimen.

3.1 Specification of UTM

Table.4 Specification of UTM

1	Max Capacity	400KN
2	Measuring range	0-400KN
3	Least Count	0.04KN
4	Clearance for Tensile Test	50-700 mm
5	Clearance for Compression Test	0- 700 mm
6	Clearance Between column	500 mm
7	Ram stroke	200 mm
8	Power supply	3 Phase , 440Volts , 50 cycle. A.C
9	Overall dimension of machine (L*W*H)	2100*800*2060
10	Weight	2300Kg

3.2 Experimental Procedure

- Fixture is manufactured according to component designed.
- Single force is applied as per FEA analysis and reanalysis is performed to determine strain by numerical and experimental testing.
- Strain gauge is applied as per FEA results to maximum strained region and during experimental testing force is applied as per numerical analysis to check the strain obtained by numerical and experimental results.
- During strain gage experiment two wires connected to strain gage is connected to micro controller through the data acquisition system and DAQ is connected to laptop. Strain gage value are displayed on laptop using DEWESOFT software.



Fig. 16 experimental setup

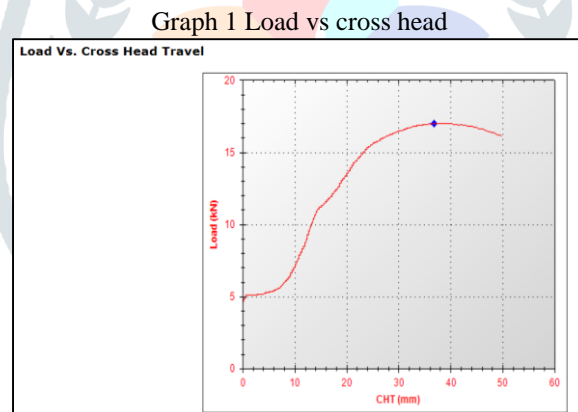

- Graph 1 show that Experimental Testing of Jute Fiber epoxy Reinforcement component taken on the UTM machine, In that Perform the compression test of the three point bending test.
- During the experimental test is performed with load of 16980 N/S. Observe for the failure of the component

3.3 Experimental FEA

From experimental testing reaction force obtained are reanalyzed in ANSYS and find the Failure and Deformation. again Boundary condition are applied.

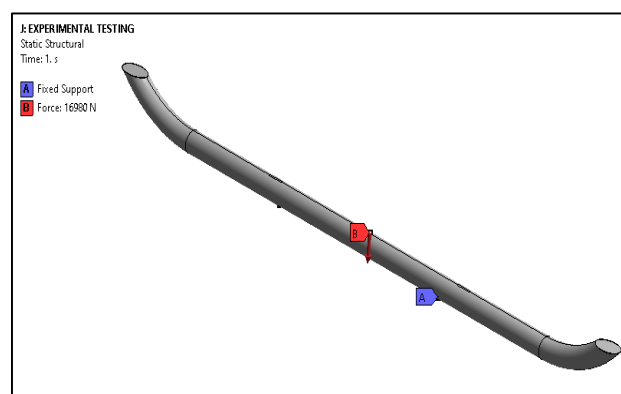

Fig. 17 boundary condition of experimental FEA

In the Reanalysis Boundary Condition are,(Show in Figure 17)

- A is the Fixed Support
- B is the Forced Applied

The value of force applied is 16980 MPA (Experimental value)

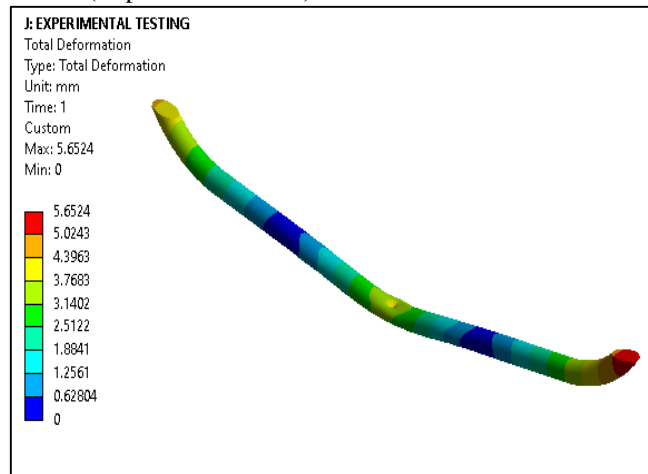

fig.18 total deformation

Figure18 show that Total Deformation is 5.6mm at the load of 16980 MPa.

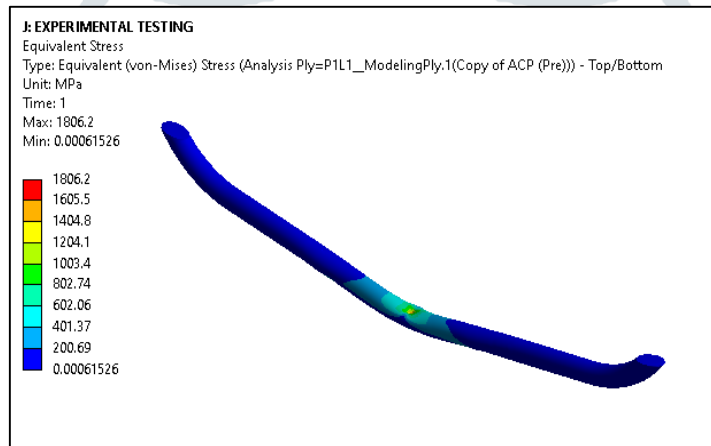

Fig. 19 equivalent stress 1 layer

Figure 19 show that Equivalent stress in 1 layer is 1806.2 MPa at load of 16980MPa (experimental testing Result)

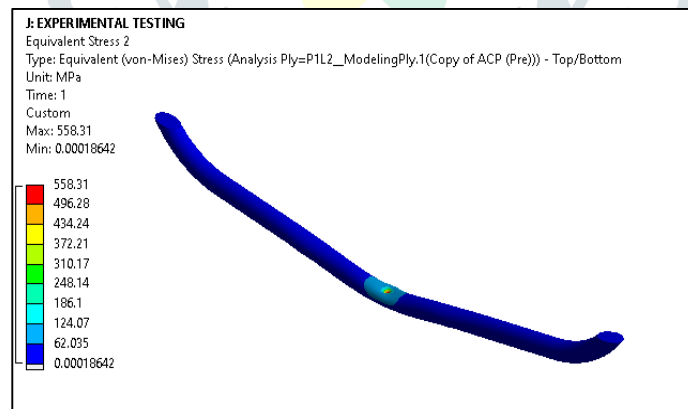

Fig. 20 equivalent stress 2 layer

Figure 20 shows Equivalent stress in 2 layer is 558.31 MPa at load of 16980MPa (experimental testing Result)

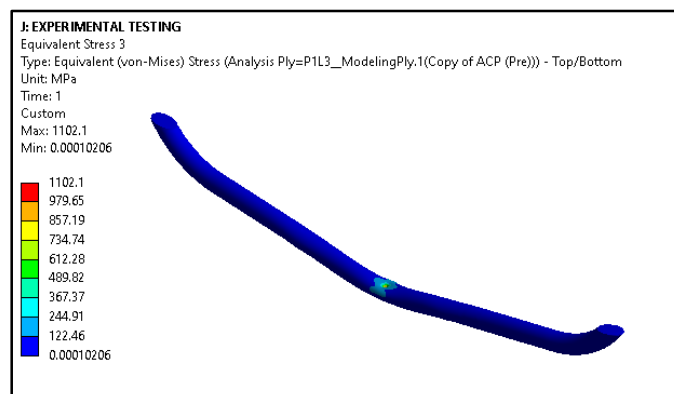

Fig.21 equivalent stress 3 layer

Figure 21 shows Equivalent stress in 3 layer is 1102.1 MPa at load of 16980MPa (experimental testing Result)

IV. RESULTS AND DISCUSSION

4.1 FEA Result Analysis

In this project we are consider three materials, existing material steel and the natural fiber Jute and Bamboo.The FEA analysis value of stress of steel and the stress value of each layer of Jute and Bamboo are show in the Graph 2.

Graph 2 show that Jute has the maximum stress value compared to Steel and Bamboo.

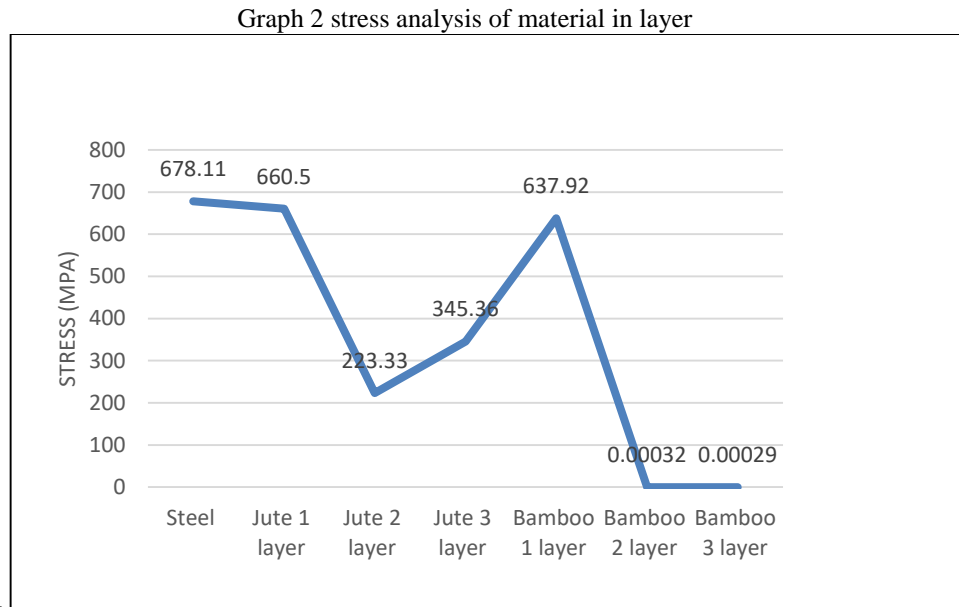

FEA analysis taken of this three materials,
Steel :

- Total Forces = 6942.7 MPa (fig .7)
- Strain Energy = 21.541 MPa (fig .8)

Jute:(ACP Tool Post)

- Total Forces = 20018 MPa (fig 12)
- Strain Energy = 44.325 MPa (fig .11)

Bamboo:(ACP Tool Post)

- Total Forces = 4435.6 MPa (fig.15)
- Strain Energy = 9.81 MPa (fig .14)

Graph 3 strain analysis material

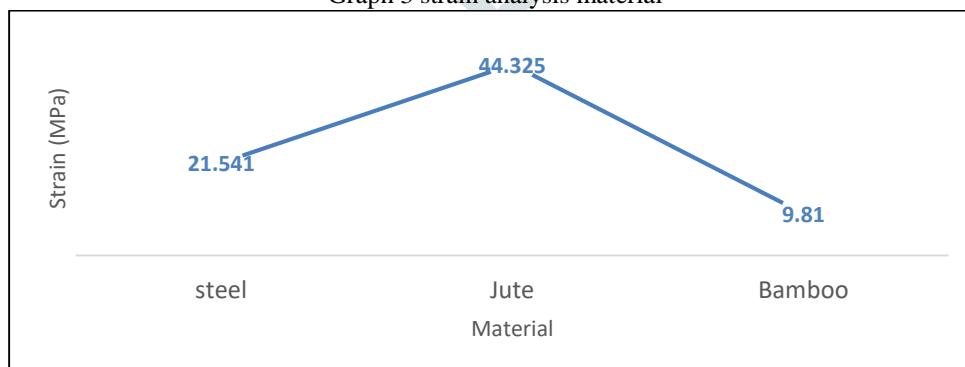

Graph 3 show that the Jute has the maximum strain energy compared to steel and Bamboo.

Graph 4 total reaction forces of material

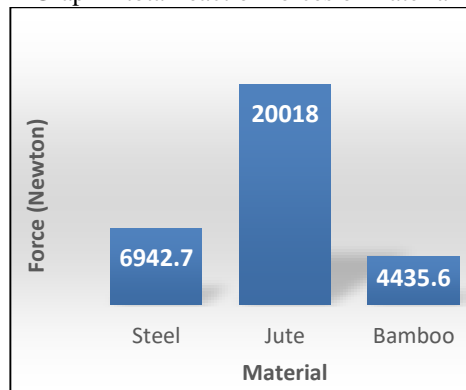

Graph 4 show that Jute has the maximum Reaction Forces compared to steel and Bamboo, so that Jute epoxy are selected for the Reinforcement of the steel.

4.2 Experimental Test Result

Experimental Testing of Jute Fiber epoxy Reinforcement component test on the UTM machine, In that Perform the compression test of the three point bending test. Show in the Graph 1.and Figure 16.

Graph 5 FEA and Experimental Result

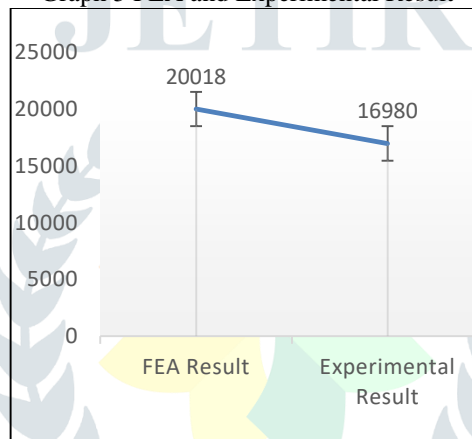

During the experimental test is performed with load of 16980 MPa. Observe for the failure of the component.

- FEA Analysis value of Jute = 20018 MPa (fig. 12)
- Experimental Value of Jute Reinforcement = 16980 MPa (Graph 1)

Result of force reaction in FEA and UTM are matched with 15% error so experiment validation are complete.(Graph 5)

4.3 Experimental FEA

In the FEA Experimental test result Reanalysis done by value of the Experimental test.

Hence 16980 MPa force value are applied on the jute Epoxy Reinforce Component and find the Total deformation and maximum stress at each layer.(Graph 6)

Graph 6 Reanalysis of stress at each layer

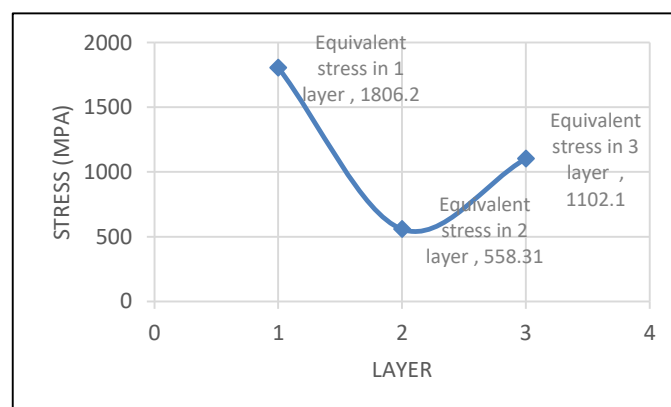

Total Deformation = 5.6mm (fig .18)

Equivalent stress in 1 layer = 1806.2 MPa (fig .19)

Equivalent stress in 2 layer = 558.31 MPa (fig .20)

Equivalent stress in 3 layer = 1102.1 MPa (fig .21)

- From experimental testing reaction force obtained are reanalysed in ANSYS to observe failure of each layer along with deformation.

V. CONCLUSION

- In present investigation bumper with existing material and composite material is compared and displacement is applied to determine stress, strain energy and force reaction.
- It is observed from analysis that force reaction obtained through jute epoxy is greater than bamboo fiber along with existing material. So, it can be used to enhance the impact energy with significant increase in weight of component.
- From experimental testing reaction force obtained are reanalysed in ANSYS to observe failure of each layer along with deformation.
- Result of force reaction of FEA and UTM are matched with 15% error so experiment validation is complete.

REFERENCES

- [1] Rear Bumper Laminated in Jute Fiber with Polyester Resin. Braga, R. A; Magalhaes Jr, P. A. A., Braga, R. A Int. Journal of Engineering Research and Applications, ISSN : 2248-9622, Vol. 4, Issue 9(Version 1), September 2014, pp.174-184.
- [2] Design Optimization and Implementation of Composite and Recyclable Thermoplastic Materials for Automotive Bumper, Giovanni Belingardi, Ermias Gebrekidan Koricho, Brunetto Martorana, Fifth International Conference on Advanced Computational Methods in ENgineering (ACOMEN 2011) Liège, Belgium, 14-17 November 2011 (c)University of Liège, 2011.
- [3] Enhancement of impact strength of a car bumper Using natural fiber composite made of jute, By p. Ragupathi, n. M. Sivaram, g. Vignesh, milon d. Selvam, research gate, July 2018
- [4] Design and analysis of automotive carbon fiber composite bumper beam based on finite element analysis by Tie Wang and Yonggang Li.
- [5] Experimental and numerical investigations of the impact behaviour of composite frontal crash structures by S. Boria, J. Obradovic, G. Belingardi.
- [6] CAE Driven Improvement in Frontal Offset Crash Performance of a Compact Car by Sanjeev Kumar, Rahul Bettakote, and Pinak Deb
- [7] Development of Adaptable CFRP Energy Absorbers for Car Crashes by Nikola Schmidová, Tereza Závřelová, Michal Vašíček, Filip Zavadil, Milan Růžička, Martin Rund.
- [8] Static and dynamic axial crushing analysis of car frontal impact hybrid Absorbers M. Costas, J. Díaz , L.E. Romera , S. Hernández , A. Tielas.
- [9] Impact properties of kenaf Fiber/X-ray films hybrid composites for structural applications A.M.R. Azmi, M.T.H. Sultan, M. Jawaidb, A.U.M. Shah, A.F.M. Nora, M.S.A. Majid, S. Muhamade, A.R.A. Talib.
- [10] Joshi S.V, Drzal L.T, Mohanty A.K, Arora S. The mechanical properties of vinylester resin matrix composites reinforced with alkali-treated jute fibers. Composites Part A: Applied Science and Manufacturing. 2001; Vol. 32, Issue 1; 119– 27.
- [11] Ray D, Sarkara B.K, Rana A.K, Bose N.R. The mechanical properties of vinylester resin matrix composites reinforced with alkali-treated jute fibers. Composites Part A: Applied Science and Manufacturing. 2001; Vol. 32; Issue 1; 119– 27.
- [12] Ray B.C. Loading Rate Sensitivity of Glass Fiber-epoxy Composite at Ambient and Sub-ambient Temperatures. Journal of Reinforced Plastics and Composites. 2006; Vol. 25; 329-333.
- [13] Li Y, C Hu, Yu Y. Interfacial studies of sisal fiber reinforced high density polyethylene (HDPE) composites. Composites Part A: Applied Science and Manufacturing; 2008; Vol. 39; Issue 4; 570–8.
- [14] Saha P, Manna S, Chowdhury S.R, Roy R.S.D, Adhikari B. Enhancement of tensile strength of lignocellulosic jute fibers by alkali-steam treatment. Bioresource Technology. 2010; Vol. 101; Issue 9; 3182–7.
- [15] Alves C, Ferrao P.M.C, Silva A.J, Reis L.G, Freitas M, Rodrigues L.B, et al. Ecodesign of automotive components making use of natural jute fiber composites. Journal of Cleaner Production. 2010; Volume 18; Issue 4; 313–27
- [16] Mr. Nitin S motgi, Prof. S.B. Naik, Prof. P.R. Kulkarni had studied about the Impact Analysis of Front Bumper. Walchand Institute of Technology, Solapur, India.Vol. 6 no.5 December 2013.
- [17] R. Ranjithkumar, J.P. Ramesh, Modelling And Analysis of a Car Bumper Using Various Materials by FEA Software, Journal of Chemical and Pharmaceutical Sciences ISSN: 0974-2115, Special Issue 9: April 2015, pp 294 -298.
- [18] Design, Modelling & Analysis of Safety Impact Guard for Heavy Duty Vehicle, Neha S. Dixit*Dr. Ajay G. Chandak, International Journal of Innovative Research in Advanced Engineering (IJIRAE)ISSN: 2349-2163Volume 1 Issue 6(July2014).
- [19] Dubem Ezekwem had studied and analyzed about the use of composite materials in frontal car bumper. Loughborough University Aug.2016.
- [20] A Review on Bamboo Fiber Composites and its Applications N. Kaur¹, S. Saxena², H. Gaur³, P. Goyal , IEEE2017
- [21] Prashanth S, Sangamesh K, Suresh T, Pramod B had emphasized about the design and analysis of composite truck bumper using FEM. Asst, professor, Dept of Mechanical Engineering, Sambhram Institute of Technology, Bengaluru560097. Vol.5 issue 1 jan 2018.
- [22] Design and crash analysis of scooter front guard ,1*R.Balamurugan, 2S.Mohamed Abdul Sukkoor, 3S.Madhankumar, 4A.Tamilselvan , © 2017 IJCRT | Volume 5, Issue 3 January 2018 | ISSN: 2320-2882
- [23] Lande P.R, Patil R.V., Analysis of Bumper Beam in Frontal collision, International Journal of Innovative Research in Science, Engineering and Technology, Vol. 4, Issue 5, May 2015, pp 2807 -2810.