

# PARATRANSITS OR INTERMEDIATE TRANSITS: A BOON OR BANE TOWARDS SUSTAINABLE URBAN MOBILITY IN KOLKATA

<sup>1</sup>Poulami Banerjee (Das), <sup>2</sup>Dr. Jayita Guha Niyogi

<sup>1</sup>Assistant Professor, <sup>2</sup>Professor

<sup>1</sup>Amity School of Architecture & Planning

<sup>1</sup>Amity University, Kolkata, India

---

**Abstract:** In India, the urban areas stand far away from the sustainability measures in the context of mobility. The main challenge of Indian cities is the high pace of urbanization and inadequate preparedness to combat the population influx. For Indian cities, the transportation lifelines are suffering from chronic ailments of constricted entry points, narrow sections, disparity with landuse zones and overall planning deficiencies contributing to suffocating traffic volume when the city is fully functional. In addition to inadequate road sections, inadequate transit facility and unsure of sustenance in the new satellites, have prompted in rise in self-driven traffic volume, making the riding condition even worse.

In Kolkata, one of the main reasons of slow traffic dispersion is allowing a mixed bag of traffic on all urban roads. In such scenario, the very definition of the paratransit loses ground, when they compete with the high-volume fast-moving transit modes on arterial roads, delimiting their speed and encroaching on their share of revenue. This ultimately leads to time wastage for passengers, depriving and destabilizing transit workers and bus owners, less number of trips per vehicle and fall in fuel efficiency and corresponding rise in air pollution due to incomplete burning of fossil fuel, rendering the entire system unsustainable and vulnerable. This paper would access the contribution of paratransit towards sustainable mobility and a sincere attempt would be made to suggest traffic management tools and strategies to integrate the transit vehicles and paratransit modes, with a special focus on Kolkata.

**Index Terms:** *urban sprawl, transportation network, mass transit, paratransit, sustainable*

---

## I. INTRODUCTION: DISCUSSION ON URBANIZATION SCENARIO AND RELATED ISSUES IN INDIA AND KOLKATA

The major trends that influence mobility of urban population in Indian cities are rapid urbanization, rising motorization and mixed modal share on urban roads. Urbanization and influx of daily floating population in cities have resulted in a stiff rise in the demand for travel. At the same time, the rapidly increasing levels of motor vehicle ownership and use have resulted in a distressing increase of negative factors such as road congestion, air pollution, road fatalities, and social issues of equity and security, thereby threatening the sustainability of urban transport system.

### 1.1 Rapid Urbanization

The trends and patterns of urbanization create new challenges to urban mobility systems. As per Census of India, 2011, in 1951, there were only five Indian cities with a population greater than one million and 42 cities with a population greater than 0.1 million. Much of Indian population effectively lived in villages settlements. In 2011, there were 468 cities with population above 0.1 million and 53 cities with population greater than 1 million (Ref. Table 1). Urban India has expanded rapidly over the last few decades and is likely to grow faster in the future. Indian cities are expected to contribute 70 per cent of India's GDP by 2030. India is world's second largest urban system (367 million in 2011) after China, with 7935 cities and towns in 2011, up from 5161 in 2001. The projected Indian urban population for 2021 is 473 million and the figure is expected to attain 820 million in 2051.

Table 1: Classification of cities as per population (vide 2011 census), Source: <http://censusindia.gov.in>

Cities as per population	No. of cities	Cities as per population	No. of cities
>10 million	3	<b>Total million-plus cities</b>	<b>53</b>
5 – 10 million	5	0.5 – 1 million	43
2 – 5 million	10	0.1 – 0.5 million	372
1 – 2 million	35	Total number of cities	468

For the first time since independence, the absolute increase in population is more in urban areas than that in rural areas. In India, urban population increased from 27.82% to 31.16% whereas the proportion of rural population declined from 72.19% to 68.84% between 2001 and 2011. The main difficulty of Indian cities is inadequate preparedness to address the population influx forcing rapid urban sprawl, Kolkata being no exception.

Kolkata's spreading urbanization, however, has been going on for at least a half century. Since 1951 Census, the central city of Kolkata has accounted for only 19% of the urban area population growth. The central city has added nearly 1,800,000 people while the suburbs have added approximately 7,650,000. Over the past two decades, the central city's growth has been minimal, adding 87,000 people from 1991 to 2011, while the suburbs added more than 3 million new residents. As per the reports of Census India, 2011, although Kolkata city has population of 4.5 million, its metropolitan population is 14.06 million. Kolkata municipality area has a compound annual population growth rate of 1% as against the compound annual population growth rate of 2% for the total urban agglomeration. This indicates the growth towards urban periphery due to new residential developments along Northern and southern fringes. At the inception of every such additional urban area, real estate industry overshadows the basic infrastructural requirements including transportation network. *The development in these new areas is not at all mass transport oriented. Low density, introvert design and segregated landuse have made these developments prone to use of more private modes or intermediate transit modes. (supporting data)*

**1.2 Rapid Motorization in India and Kolkata**

In 2016, a total of 230 million vehicles got registered in India, out of which 73.5% and 13.1% vehicles have been contributed by two wheelers and cars/ jeep/taxis respectively, as compared to 0.8 % contribution of buses. But the point of concern is, in India, CAGR for registered vehicles from 2006 to 2016 is 9.9%, while the GAGR for road length from 2006 to 2016 is 3.7, as per the Road Transport Year Book, 2015-16.

Figure 1: Comparative Analysis of growth of core and suburban population from 1901-2011,

Source: <http://censusindia.gov.in>

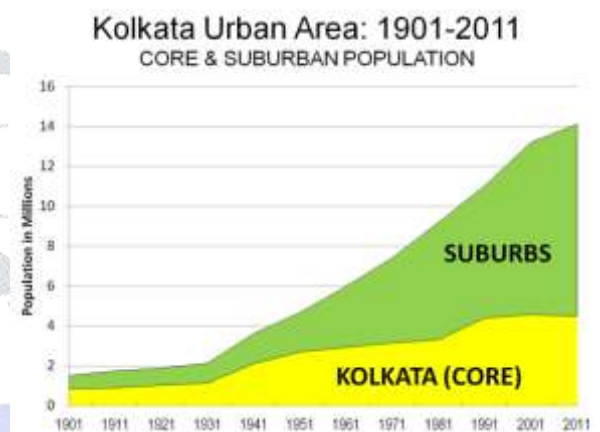

Figure 2: Growth of Registered Vehicles in India, 2006-2016; Source- Statistical Year Book, 2018, mospi.gov.in

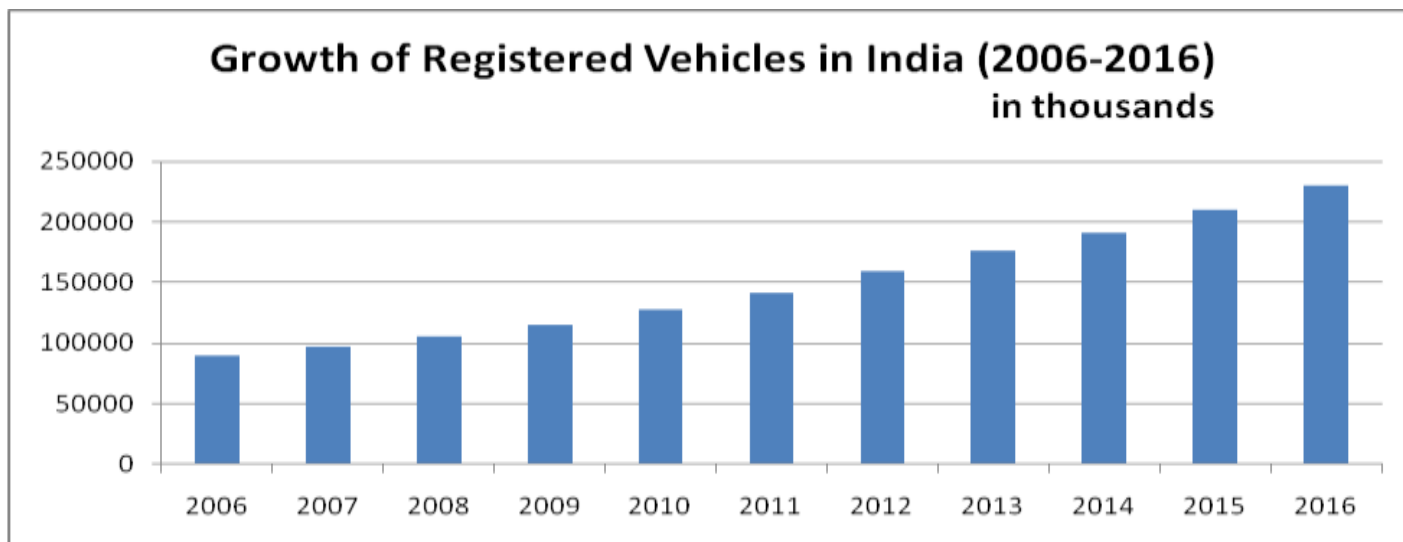
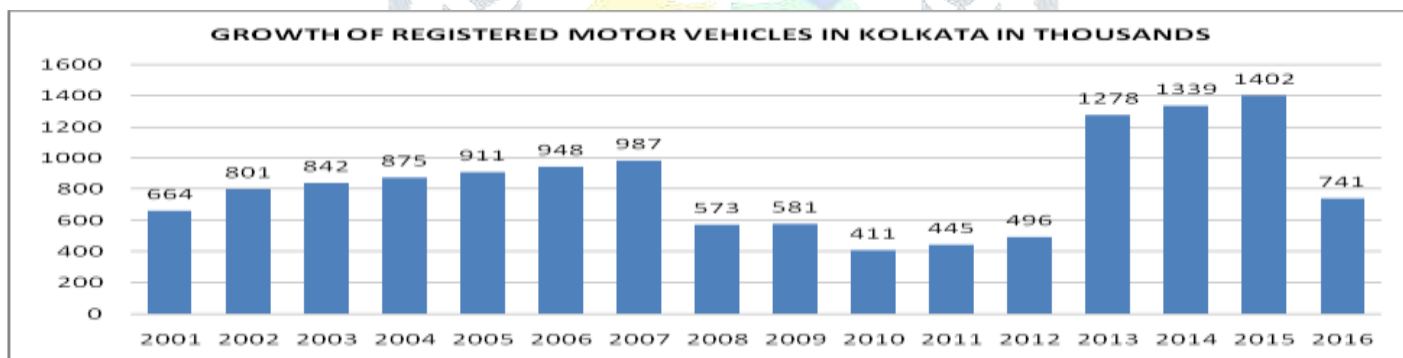

Table 2: Modal Split of Registered Vehicles in India in 2016, (TRANSPORT AND NON TRANSPORT as on 31st March, 2016),

Source: Transport Research Wing, Ministry of Surface Transport

	Buses	Car/ Jeep/ Taxis	Goods vehicles	Two-wheelers	Miscellaneous	Grand Total
	% of total vehicle population					In Million
<b>2016</b>	0.8	13.1	4.6	73.5	8.1	230

Figure 3:Growth of Registered Vehicles in Kolkata (in thousands) from 2001 -2016; Source- Statistical Year Book, 2018, mospi.gov.in



Out of five metro cities, Kolkata has registered 1.4 million of vehicles, which accounted for 2.12% of the total registered vehicles in 50 million plus cities in India, as per MORTH, India. In 2016, Kolkata had a total of 0.74 million of vehicles, which accounts for less than 1% of total registered vehicles in India. There has been sharp drop of registered vehicles, nearly by 50%, from the year 2015 to 2016. This may be attributed to the slower economic growth of the state during the period, withdrawal of BS I- BS III vehicles from road, strict vigilance on truck traffic during day time and the upcoming election in West Bengal in 2016.

It is observed that, two-wheelers and cars are the dominant form of transport modes in Kolkata which are unsafe, environmentally damaging, and unsustainable. But one striking fact is bus volume constitutes only 1% of the total traffic volume.

Figure 4: Comparative Analysis of Modal Shares in Kolkata between the years 2014-15 and 2015-16; Source- Statistical Year Book, 2018, mospi.gov.in

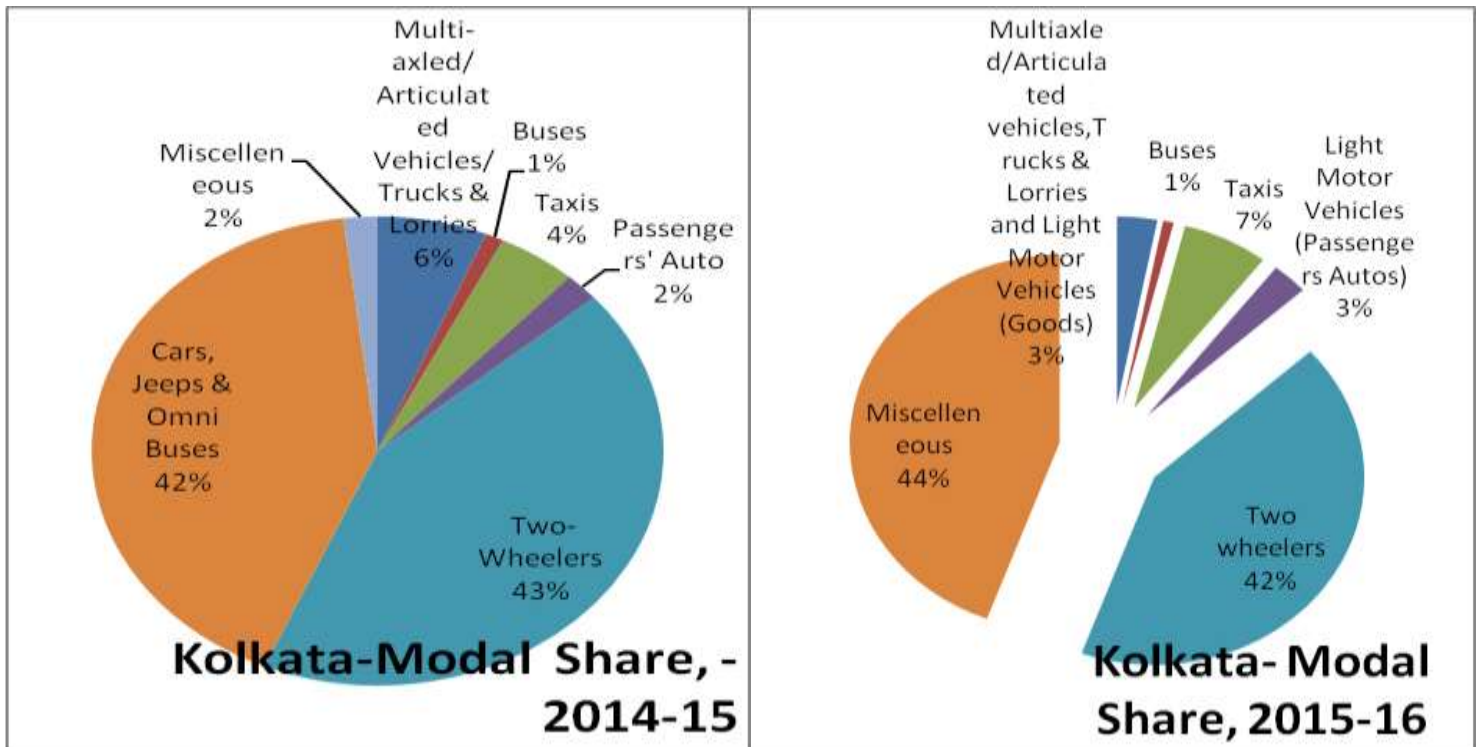

Further, inadequate transit facilities, unsure of sustenance in the new satellites growths in the urban peripheries, often prompt in sharp rise in the share of self-driven vehicles, making the riding condition and emission even worse.

In addition to large number of private vehicles, Kolkata is also has ever growing nuisance of paratransit modes (refer to figure 4, autos have increased by 1% and taxis by 3% of total modal shares in Kolkata from 2014-15 to 2015-16) competing with mass transit and other modes on main arterial roads making the whole situation more suffocating. The tough competition from autorickshaws and taxis have resulted in reduction of bus fleet. The rising fuel and maintenance cost are also responsible for the withdrawal of the buses. The paratransit modes like auto rickshaws, totos, rickshaws should complement the buses rather than compete with them. The rapid growth of the paratransit modes within the city is owing to the increased local demand for transport. The Centre of Policy Research and iTrans have carried out a study on paratransit transport system in Kolkata and have found that among all para-transits, in 2017 the shares of auto rickshaws and rickshaw were 46.5% and 34% respectively. As per the study, auto is the most popular mode of para transit mode in Kolkata. Kolkata, advertently or inadvertently are blessed with very good network of Autos, plying on fixed routes (127 routes) on a stage carriage model, permitted by Regional Transport Authority (RTA) and operated by the private owners. As on 2017, Public Vehicles Department has permitted 11,315 four stroke LPG autos in KMA areas to ply in all the routes, permitted by RTA. Unofficially, the numbers may be higher. In addition to these auto rickshaws there are ever growing numbers of yellow and App taxis and cycle rickshaws in the city.



**II. IDENTIFICATION OF PROBLEM: A DILEMMA BETWEEN MASS TRANSIT AND PARATRANSIT**

Travelling is a disutility unless it's a leisure trip. Most trips in urban areas are work trips where people spend time and money, gather fatigue for the salary they earn. Poor road conditions and reduced speed vexes commuters. It is a planner's duty to plan for comfortable commuting so that one can deliver his/her best to improve GDP. In cities like Kolkata,

Table 3: Percentage of Landuse Zones of Kolkata

Source: Kolkata Metropolitan Development Authority, Vision 2025.A Perspective Plan for Kolkata – 2011, Supp.Vol-I, State Board, Govt. of West Bengal, Nov. 1990

roads are constricted due to organic growth. Construction of flyover and ring roads cannot solve the problem of road congestion, as vehicular growth is an inevitable phenomenon as population growth in India. One solution which now in discussion amongst the transportation planners, is to promote mass transit modes more in cities to obtain reduced PCU on road and that is the most economic solution to resource-starved developing countries. Fewer vehicles would improve road speed and pollution load. But mass transit also has its own adversities. Regulations also exist in India with respect to proportion of each activity/ landuse and share of roads is also defined to connect each activity adequately to facilitate flow of work force, raw and finished products as adequate transport facilities ensure unhindered economic activities. But the irony is Indian cities do not satisfy the requirement of road quantity as per standards. For example, Comprehensive Mobility Plan of KMDA (2007) says Kolkata has about 5.5% space for roads.

No.	Land Use	Area in Sq. Km.	Per cent
1.	Agricultural & Vacant Land	421.4	31.21
2.	Commercial & Industrial	611.8	45.32
3.		89.5	6.63
4.	Parks & Open Space	12.1	0.89
5.	Educational Activities	33.6	2.49
6.	Transport Activities	73.6	5.45
7.	Others including Recreational	108.0	8.01
	<b>Total</b>	<b>1350.0</b>	<b>100.00</b>

In urban areas of Kolkata the commuters use following modes:

- Walking
- Bicycling
- Private Modes
- Transit Modes: Tram, Metro, Bus, minibus: Fixed routes, predefined interval
- Intermediate Public Transport (IPT) modes: Shared rides: motor-cycle rickshaw, auto rickshaw, cycle rickshaw, tonga,

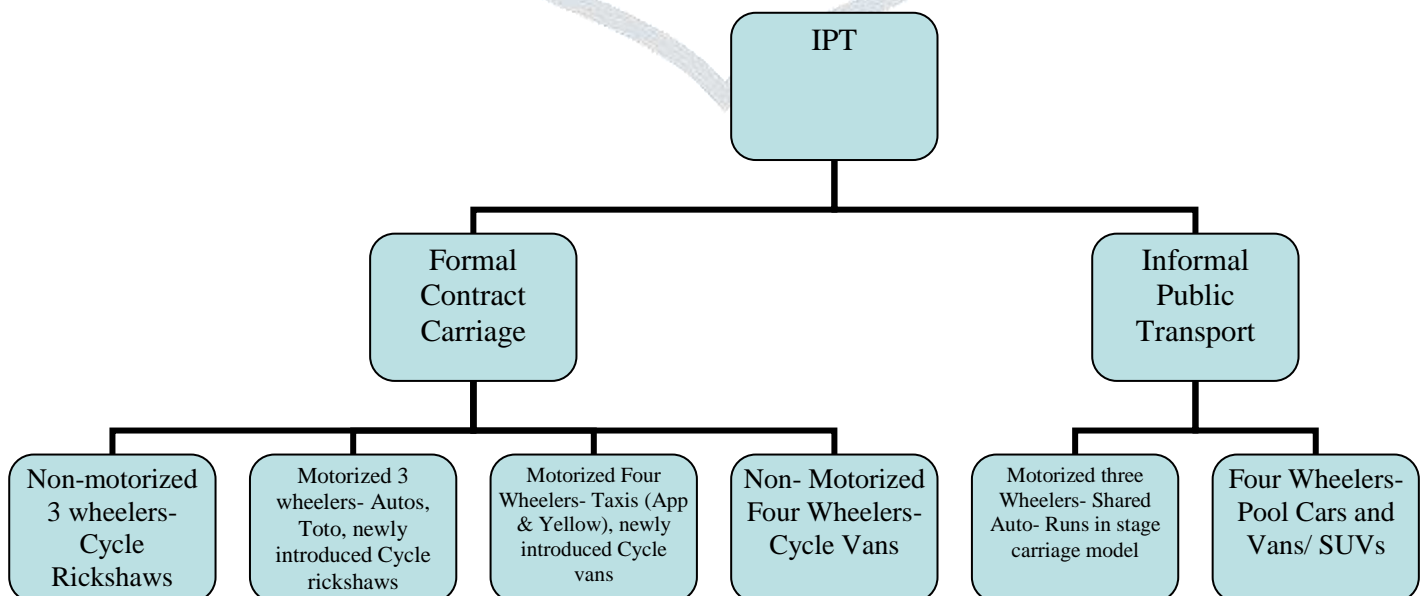

Figure 5: Categorization of Paratransit, as observed in Kolkata

taxi, trekker, toto, SUV [Kadiyali Chapter 45]

- ❑ In North America Paratransit is recognized as special transportation services for people with disabilities that supplement fixed-route bus /rail systems. Paratransit services may vary considerably on the degree of flexibility they provide their customers.
- ❑ In India, initially people used paratransit (rickshaws) modes to access the transit corridor.
- ❑ Later, people started using mechanized paratransit modes to quicken movement along transit corridors giving rise to conflict.
- ❑ As per Centre for Urban Studies, CPPR Policy Brief, Series II, Vol 2, 2014- “Intermediate Para Transit (IPT) is a system to facilitate flexible passenger transportation that does not necessarily follow fixed routes and schedules under the public domain. They provide two types of services: one involving trips along a more or less defined route with stops to pick up or



Figure 6: Clipping from "Time of India"- An English daily, Kolkata Edition, dated 02.02.2016



Figure 7: Traffic Snarl at Ultadanga Crossing, PC: Sayantan Ghosh area”.

discharge passengers on request. The other is a demand-responsive transport which can offer a door-to-door service from any origin to any destination in a service

Thus, IPT can have two sectors, Formal and Informal, in case of Kolkata, as shown below:

Although buses have many advantages, viz: carry more passengers at a time, less number of vehicles required for same number of commuters, when compared to private vehicles and affordability. Thus, carbon emission would be less and also there would be less number of accidents, due to minimal modal clash.



Figure 8:PC: Press-Office City of Muenster, Germany

But, primary survey on commuters, conducted by Centre for Policy Research (CPR), Innovative Transport Solutions (iTrans) and Centre for Urban Economic Studies (CUES), Calcutta University, in the year 2016 reflects that most popular modes of transport for short distances in Kolkata is NMT, followed by IPTs (rickshaw and auto rickshaw). Though large number of commuters prefer taking public transport (buses) in Kolkata (54%), compared to other metro cities, yet during daily peak hour modal mix at busy crossings is observed with scanty proportion of buses as compared to taxis, private cars and IPTs. With reference to the figure numbered four, it can be observed that, almost all roads in Kolkata are over occupied, mostly due mixed modes plying on comparatively narrow lanes.

Kolkata hosts a mix of all classes of people necessitating presence of bus transit for urban poor who are majority. However, a commuters' survey reflects that, upper middle class and higher income group do not prefer to commute by bus due following reasons.

Kolkata is a city, with mix of all classes of people. Commuters' survey reflects that, from upper middle class to higher income group do not prefer to commute by bus due to following reasons:

- Buses take more **time** to reach any destination compared to IPTS, taxis and private cars. This due to **more numbers of stoppages and congestion due to mix of modes on roads**. On a major road in Kolkata (VIP Road), for a small distance of 8.64 Km, there 22 stops and average distance between stops is 392 m, highest being 1Km and lowest being as short as 160 m. Buses have **longer trip lengths** in metro cities. **Waiting time for buses is also more**, adding to the travel time.

Table 4:Distance between stoppages, VIP ROAD, Kolkata, 2017, Primary Survey by Author

FROM	TO	TRAVELLING DISTANCE (in metres)
HUDCO Bus Stop	Ultadanga Bus Stop	300
Ultadanga Bus Stop	Gola Ghata B.S.	850
Gola Ghata B.S.	Sreebhumi B.S.	450
Sreebhumi B.S.	VIP Laketown B.S.	400
VIP Laketown B.S.	Bangur	650
Bangur	Deshprijaparh	300
Deshprijaparh	Dum Dum B.S.	350
Dum Dum B.S.	Nasay	300
Nasay	Kestopur (Reebok)	140
Kestopur (Reebok)	Kestopur (Adarshpally)	160
Kestopur (Adarshpally)	Mukesh Hyundai	200
Mukesh Hyundai	Majher Para	230
Majher Para	Baguihati B.S.	290
Baguihati B.S.	Jora Mandir B.S.	350
Jora Mandir B.S.	Big Bazaar	350
Big Bazaar	Rose Valley	350
Rose Valley	Raghunathpur B.S.	170
Raghunathpur B.S.	Teghoria	300
Teghoria	Haldiram	650
Haldiram	Malatari Camp	350
Malatari Camp	Kaikhali B.S.	500
Kaikhali B.S.	Airport Gate No. 1 B.S.	1000
<b>Average distance between stops (22 Nos.)</b>		<b>392.73</b>

Figure 9:Clipping from Ananda Bazaar Patrika, a Bengali daily dated 30/11/2015



- Poor condition of public transport, **crowded, overloaded and risky**. Even the air-conditioned buses started by government are crowded, due to preference over non air-conditioned buses.
- Longer routes for some of the buses.
- Uncomfortable riding condition and poor design of buses and footpath, with no consideration for disabled people.
- Chaotic traffic management, allowing overtaking, rash driving to mention few.
- With reference to figure number 8, it has been also observed that to facilitate the commuters of the new satellite settlements in Newtown and Garia, the main city buses are proposed to take detour with enhanced fares. Dedicated buses



cannot be allotted for the new satellite settlements due to sustainability issues. This in turn would again prolong the trip length and time and also reduce the frequency of trips.

Thus the commuters in Kolkata as well as other metro cities prefer paratransit modes for shorter distances and taxis or privately owned four wheelers for longer distances to avail smoother riding conditions. Autos are the most preferred paratransit mode in Kolkata. Kolkata actually has very good network of auto rickshaws operated by private owners and permitted by Regional Transport Authority. Unlike other cities, where autos are permitted to ply anywhere within the urban boundary, in Kolkata autos ply on specific routes. It operates on a stage carriage model in 127 routes, subject to approval of Public Vehicles department. As of 2017, total number of LPG auto permits issued by the department was 11, 315. The paratransit modes have their own pros and cons as they compete on main roads with the mass transit modes, as discussed below. The advantages of paratransit modes are:

- Seats per vehicle being limited, waiting time minimized.
- Frequencies of trips made are more in numbers.
- The commuters can move seated and they can board and get down anywhere they prefer.
- The commuters can move faster with small rise in out of pocket cost.

The disadvantages of paratransit modes are:

- Unprecedented hike in PCU load on road, due to mixed bag of traffic.
- Average speed on road reduced.
- Pollution load multiplied with more car and less speed.
- Economic viability of all transit modes on main roads gets crippled. Government has introduced AC buses with higher fare to bridge the loss. But then the private owners have started withdrawing their buses as they were incurring loss.
- Paratransit modes have more frequency; thus, they have more fuel demand, parking demand and road encroachment. Experts may argue
- Paratransit operators are stressed to the limits with longer duty hours, driving as well as collecting fares, inadequate currency changes, competition, rough road condition, etc.
- Misbehavior from paratransit operators. Conductors in buses - a better interface. Currency crunch better managed.
- Sudden braking and accelerating adversely affects road quality.

### III. AN ASSESSMENT OF AN INTERSECTION ON KAZI NAZRUL ISLAM SARANI IN KOLKATA

Sustainable mobility is defined as “Sustainability that targets economic efficiency, environmental justice and social equity by including policies for integrating landuse and transport planning, ensuring adequate transport supply measures, managing travel demand efficiently, and incorporating environment- friendly strategies and policies”. (Haque, et al. (2013)).

There is a growing consciousness about sustainable development, in all sectors in the developed and developing countries. The developing countries are struggling to implement sustainable measures to attain a balanced development due to many constraints, viz. land scarcity, financial constraints, unplanned developments, etc.

In Kolkata, the dilemma of allowing the PTS to ply with the mass transit modes on arterial roads have kept the administrative allured, as on one hand it's a preferred mode for public and it is sustainable in terms of economic parameters and on the other hand it suffocates the main stream traffic. The unfulfilled demand for rapid and economic transport modes has given rise to **PARATRANSIT SYSTEM (PTS)**, e.g., rickshaws, auto rickshaws, taxis, totos pool cars, etc. **PTS** fills up the gap within the organized public transport system. The flexibility of PTS forms an imperative support system to the public transport system in

Figure 10:Location 'A' of study area, Source- Google Maps





the urban areas of all developing countries. Lack of infrastructure, insufficient operational controls, insufficient training, irregular monitoring make the PTS unsafe. So, an optimal sustainable solution is desirable to make both PTS and mass transit can run safely on roads of Kolkata.

A primary study has been taken up along the major nodes of Kazi Nazrul Islam Sarani (VIP Road) and Jessore road. The clock tower node is the busiest signalized intersection on VIP Road. Thus, the data pertaining to this node has been analyzed to see find out delay at signals, modal mix, traffic volume and the economic modalities for different modal choices.

**Location A: Clock Tower Square, Laketown- Vip Road**

Figure 11: Average Peak Hour Modal Split and Numbers of Vehicles on Weekdays at Clock Tower Square, Laketown- VIP Road from 8:00am to 12 Noon

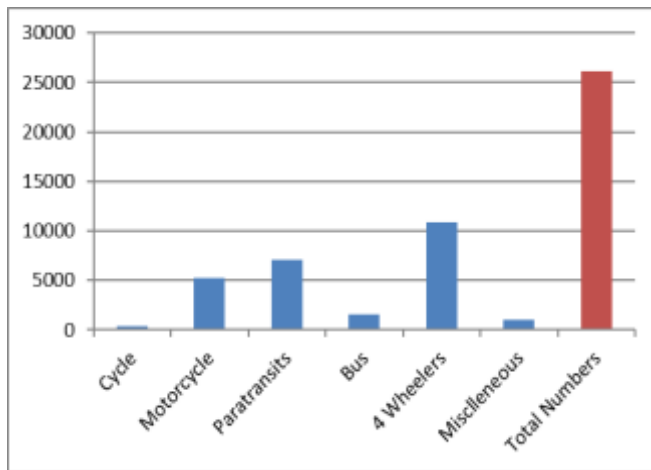

Figure 12: Average Peak Hour Modal Split and Numbers of Vehicles on Weekdays at Clock Tower Square, Laketown- VIP Road from 5:00 pm to 8:30 pm

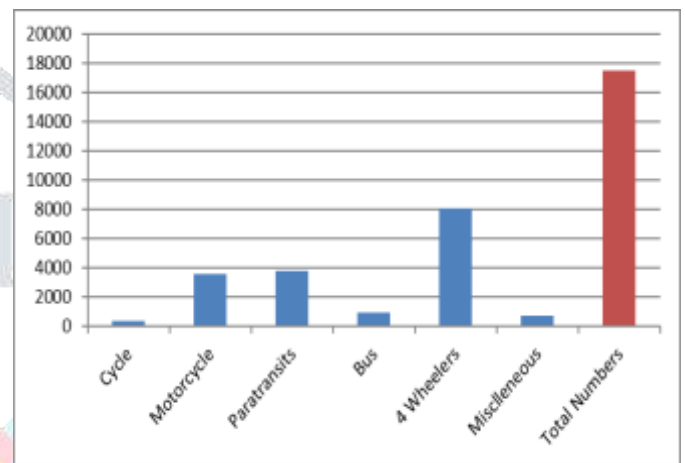

Figure 14: Average Peak Hour Modal Split and Numbers of Vehicles on Weekends at Clock Tower Square, Laketown- VIP Road from 8:00 am to 12 Noon

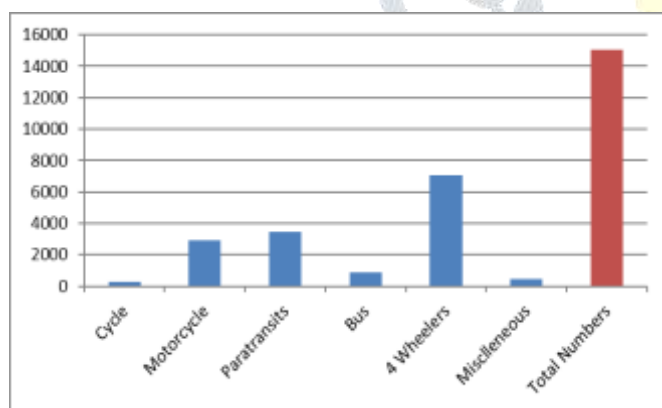
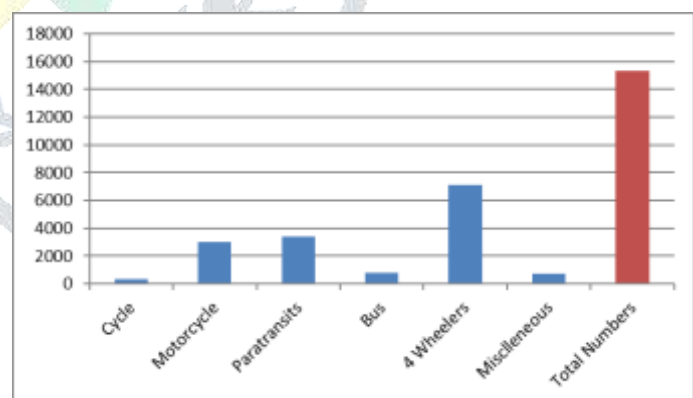

Figure 13: Average Peak Hour Modal Split and Numbers of Vehicles on Weekends at Clock Tower Square, Laketown- VIP Road from 5:00 pm to 8:30 pm



**Inferences:**

- a) Four wheelers and two wheelers are most dominant modes of transport on VIP Road.
- b) The traffic volume decreases over weekends due to less number of two wheelers and four wheelers on road
- c) **Most important observation is that the buses are less in numbers and their individual contribution to traffic volume remains the same over all days in a week.**

Its an established fact that two wheelers and four wheelers are the most undesirable modes on the urban roads in terms of pollution, road space, congestion, fatality records and financial modalities. Extensive research has already been taken up various scholars around the globe on optimization on use of cars and two wheelers on urban roads of developing countries.

Cars and wheelers have clearly outnumbered the mass transits viz. buses, on VIP road. The competition is actually between the mass transits and paratransits, as observed from the above figures (11-14). To assess whether the paratransits are boon or ban on urban roads, the following parameters can be studied:

- Road space
- Air Pollution
- Passengers travelling
- Delay at intersection
- Congestion

In general terms, dimension is the only measure for space occupation.

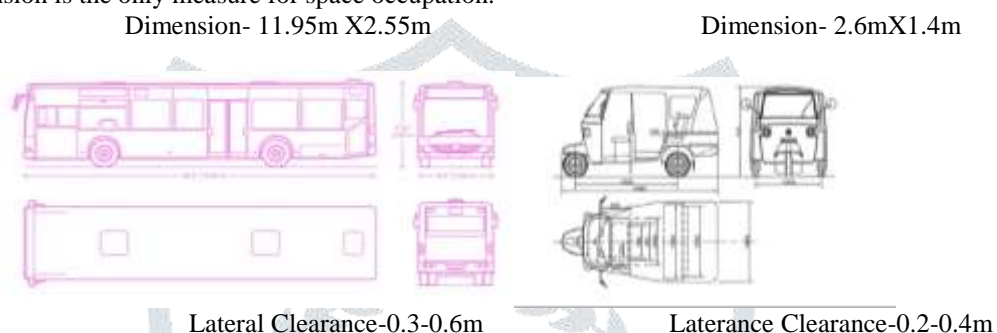

The consumption of road space is more in case for mass transits, so they run on demarcated lanes.

The consumption of space is less for paratransits. Thus, they ply inbetween lanes, creating congestion on roads, and sometimes fatal accidents too, while competing with buses.

When the peak hour volumes have been studied in the survey location, it has been observed that about 23% to 25% of the road is occupied by the paratransit, whereas buses plying only amount to 13% to 15% (Refer to Table 5).

Table 5:Contribution of Modes in percentage in peak hour volume at survey location; Compiled by Author from Primary Survey

		Peak Hour Volume in PCU/hr	Contribution of Paratransit	Contribution of Buses	Contribution of Two Wheelers	Contribution of Private Cars	Contribution of Others	Actual Flow Rate in PCU/ Hr
Week Day-8 <sup>th</sup> March, 2018	Day 1- Morning Peak Hours	16393	25%	15%	10%	37%	13%	18197
	Day1- Evening Peak Hours	10812	23%	13%	10%	41%	14%	11293
Week End-18 <sup>th</sup> March, 2018	Day 2- Morning Peak Hours	8793	23%	15%	9%	42%	12%	9610
	Day 2- Evening Peak Hours	9968	23%	13%	10%	40%	15%	10426

It can be observed that the actual flow rate or the peak hour volume is much more than design volume of 5400pcu/hr on a two way divided 6 lane road cross section (IRC 160-1990).

Due to presence of these paratransits on intermediate lanes, the speed of mass transit decreases and as a result, there is an increase in congestion and delay. That inturn again causes rise in vehicular emission and loss of time and money.

The recurrent congestion at the selected intersection is due to network morphology, network control and multiple interactions on homogenous roads (Traffic Congestion scenario of third world by William Vickrey (2004)). It has been observed that the average speed of vehicles during peak hour at the selected approach on VIP road varies 15km/hr to 18km/hr. Inadvertently, the speed of autos, two wheelers and 4 wheelers are on a higher side than the buses due to more linear and lateral space requirement for buses and also for multiple stoppages. The speed of buses limits to 10km/hr during peak hour traffic and 18km/hr to 20km/hr

for the paratransits, as per primary survey. As per West Bengal Pollution Control Board, there is a relationship between speed of the vehicles and emission levels. Based on that, per capita pollution caused by bus and paratransits have been worked out in the following table.

Table 6: Comparative Analysis of contribution of air pollution by Bus and Paratransits plying at given speeds in gm/km on per capita basis, Compiled by Author

Pollution in gm/km	Bus at speed upto 10km/hr	Avg. Number of travellers in a BUS	Pollution per capita/gm/km	Paratransit at speed upto 25km/hr	Avg. Number of travellers in a Paratransit	Pollution per capita/gm/km
SPM	572	38	15.05	284	5	56.8
RPM	372	38	9.79	186	5	37.2
CO	22.6	38	0.59	21.6	5	4.3
HC	5.7	38	0.15	2.6	5	0.5
NO <sub>x</sub>	22.3	38	0.59	2.17	5	0.4
SO <sub>2</sub>	32	38	0.84	18	5	3.6

Under this scenario, if the percentage of paratransits, outnumber the buses plying on arterial roads (as shown in table 5), the air would be suffocating to breathe for commuters. This suffocation actually increases with reality due to congestion and delay on arterial roads of roads.

Due to mixed bag traffic congestion indices on these arterial roads are also on a higher side and waiting time at signals also increases resulting in delays. The identified congestion indicators are travel time, average speed of journey & congestion index. Thus, congestion can be summarized by:

- Congestion Index
- Travel Rate Ratio
- Delay Rate Index (Identifies magnitude of the mobility problem in relation to actual conditions)

**Congestion index (CI) =  $(C-C_0)/C_0$ ; where, C is the actual travel time on a designated stretch, C<sub>0</sub> is the free flow travel time on the same stretch.** When CI is near to zero, it indicates low congestion level and when CI>2, it indicates severe congestion.(Levinson et al, 2007).

If we consider the selected approach, the average speed of vehicles for 654m behind the approach and 400 m ahead of the junction, the average speed is 15km/hr with stoppage time of 5 minutes at the intersection during peak hours. The free flow travel speed for the corridor is 27km/hr and the minimum signal time in lean period is 2 minutes at the junction (from primary survey). Thus, CI for the selected stretch is 2.11 and hence this indicates severe congestion.

**Travel rate ratio (TRR)=Congested travel rate (minutes per metre) / Free flow travel rate (minutes per metre)** (Levinson et al, 2007). Thus, the TRR is estimated as 27/15, i.e. 1.8.

**Delay rate index=Delay Rate (minutes per metre) / Congested travel rate (minutes per metre), where in Delay Rate= Congested Travel Rate (minutes per metre) - Free flow rate (minutes per metre)** (Levinson et al, 2007). From the above data, it has been computed as 0.45

Thus, from HCM (2010), the LOS of the approach is “D”.

If a condition can be envisaged where the arterial roads would have only buses and if we assume that the paratransits would be withdrawn by atleast 40% (approximately) of total PCU volume (Autos, Rickshaws, Vans, single ridership taxis), the same approach might have a different scenario.

Table 7: Contribution of Modes in percentage in peak hour volume at survey location; Compiled by Author as a envisaged situation, without Autos, Rickshaws and single rider taxi on arterial road (in this case the surveyed approach on Kazi Nazrul Islam Sarani)

		Peak Hour Volume in PCU/hr	Contribution of Paratransit in PCU/ Hr	Contribution of Buses in PCU/ Hr	Contribution of Two Wheelers in PCU/ Hr	Contribution of Private Cars in PCU/ Hr	Contribution of Others in PCU/ Hr	Actual Flow Rate in PCU/ Hr
Week Day	Day 1- Morning Peak Hours	14757	17%	17%	11%	41%	15%	16396
	Day1- Evening Peak Hours	9861	15%	14%	11%	45%	16%	10957
Week End	Day 2- Morning Peak Hours	7940	15%	17%	10%	46%	13%	8822
	Day 2- Evening Peak Hours	9133	15%	14%	11%	43%	16%	10147

It can be observed from table 9 that the peak hour volume is not as much as the design volume of 5400pcu/hr on a two way divided 6 lane road cross section (IRC 160-1990).

When percentage of paratransits are less, it can be inferred from table 8 that per capita pollution rate would be lower than that of the previous scenario.

Lomax et al (1997) developed (i) segment delay equations (1 and 2) to measure total delay (volume or person weighted traffic delay) in a corridor or in an urban area and is calculated as the sum of individual segment delays.

$$D_s = [TT_{ac} - TT_{ap}] \times V_p \tag{1}$$

$$D'_s = [TT_{ac} - TT_{ap}] \times V_p \times V_{oc} \tag{2}$$

Where,

$D_s$  = segment delay (vehicle-minutes)

$D'_s$  = segment delay (person-minutes)

$TT_{ac}$  = actual travel time (minutes)

$TT_{ap}$  = acceptable travel time (minutes)

$V_p$  = vehicle volume in the peak-period (vehicles)

$V_{oc}$  = vehicle occupancy (persons/vehicle)

Thus, from equation (1) it can be inferred that if peak hour volume is directly proportional to delay. If, volume decreases, delay also reduces, thereby congestion also reduces on arterial road.

Due to withdrawal of about 30%-35% paratransits from road, it is assumed that at least 15% increase in peak hour traffic speed. If we consider the selected approach, the average speed of vehicles for 654m behind the approach and 400 m



ahead of the junction, the average speed is increased to 17.25km/hr with stoppage time of 4 minutes(decreased) at the intersection during peak hours. The free flow travel speed for the corridor is 27km/hr and the minimum signal time in lean period is 2 minutes at the junction. Thus, CI for the selected stretch is 1.8 and hence this indicates moderate congestion.

The travel rate ratio reduces to 1.6 and the delay rate index reduces to 0.37

Thus, LOS for the approach stands at “C”.

Table 8: Percentage decrease in Congestion Indicators with withdrawal of paratransits from arterial road;

Compiled by Author

% Decrease in Peak Hour Total Volume	% Decrease in Peak Hour Volume for Paratransit	% Increase in Actual Speed	Decrease in CI	Decrease Travel Rate Ratio	Decrease in Delay Rate Index
10%	34%	15%	15%	11%	18%

Therefore, it can be observed with a minimal increase of speed, the congestion indicators also decreased by considerable percentage.

## CONCLUSION

The arterial roads are meant for public transports but have been forcefully occupied by other modes. But, these modes, like autos, shared taxis, single rider taxis, can transfer people at higher speed and have their own conveniences. From equation (2) of Lomax et al it can be observed that smaller the number of riders, less is the delay. Thus, it is not possible to eliminate these paratransit modes totally urban transportation fabric. The riders prefer them and apart from that, as planners we have social responsibility to think about socio economic viability of all kinds of transport operators as well. Thus, the mass transits and paratransits may be proposed to operate on urban roads in integration, rather than competing on same lanes.

Therefore, linkages the public transportation systems with a reliable and passenger friendly PTS would be essential to reduce the traffic congestion, travel time and reliance on private transport.

## REFERENCES:

- [1] Indian Institute of Human Settlement, 2015, Urban Transport in India: Challenges and Recommendations, RF Paper on Urban Transport, June
- [2] World Commission on Environment and Development (1987). Our Common Future. Oxford: Oxford University Press. p. 27
- [3] Beatley T, 1995, “Planning and sustainability: the elements of a new (improved?) paradigm”, Journal of Planning Literature, 9, 383-395
- [4] Haque, M. M., Chin, H. C., and Debnath, A. K. (2013), "Sustainable, safe, smart—three key elements of Singapore’s evolving transport policies" Transport Policy, 27, 20-31
- [5] URDPFI: Urban & Regional Development Plans Formulation and Implementation Guidelines (2014), Ministry of Urban Development, 2014
- [6] TERI-NFA Working Paper No. (11), “Defining Sustainable Urban Mobility”
- [7] India Infrastructure Report 2008, MOUD, “Urban Transport”
- [8] Tiwari, Geetam, IIT Delhi, International Transport Forum, Discussion Paper 2011-18, “Key Mobility Challenges in Indian Cities”
- [9] National Institute of Urban Affairs, “Urban Transportation in Indian Cities”
- [10] Kadiyali, L. R. & Lal, N. B. (2008-09), “Principles and Practices of Highway Engineering”, Khanna Publishers, Delhi-6.
- [11] <http://censusindia.gov.in>
- [12] Comprehensive Mobility Plan of KMDA (2007)
- [13] Kolkata Metropolitan Development Authority, Vision 2025.A Perspective Plan for Kolkata – 2011, Supp.Vol-I, State Planning Board, Govt. of West Bengal, Nov. 1990
- [14] Centre for Urban Studies, CPPR Policy Brief, Series II, Vol 2, 2014
- [15] Centre for Science and Environment, 2018; Reducing Footprints: A Guidance Framework for Clean and Low Carbon Transport in Kolkata, Pg-36
- [16] Traffic Congestion scenario of third world by William Vickrey (2004).
- [17] IRC 160-1990
- [18] Timothy J. Lomax and David L. Schrank, Texas Transportation Institute, “Using Travel Time Measures to Estimate Mobility and Reliability In Urban Areas”

- [19] Dr. Lopamudra Bakshi Basu Assistant Professor, Department of Geography, Heramba Chandra College, Kolkata, WB, India, IOSR Journal Of Humanities And Social Science (IOSR-JHSS) Volume 22, Issue 7, Ver. 16 (July. 2017) PP 19-24, "Growth and Development of Autorickshaws in Kolkata: An Enigma to Planners"
- [20] Amudapuram Mohan Rao, Kalaga Ramachandra Rao, Central Road Research Institute, New Delhi and Indian Institute of Technology Delhi, Department of Civil Engineering, New Delhi, International Journal for Traffic and Transport Engineering, 2012, 2(4): 286 – 305, "Measuring Urban Traffic Congestion – A Review"
- [21] S. Vasantha Kumar and R.Sivanandan, Proceedings of International Conference on Advances in Architecture and Civil Engineering (AARCV 2012), 21st – 23rd June 2012; Paper ID TRA120, Vol. 1, "Congestion Quantification Measures and their Applicability to Indian Traffic Conditions"
- [22] Nilanchal Patel, CFMR, Alok Bhushan Mukherjee, DFMR, Birla Institute of Technology, Mesra, Ranchi, Department of Remote Sensing, Jharkhand, India; Bulletin of Geography. Socio-economic Series / No. 30 (2015): 123–134; "Bulletin of Geography. Socio-economic Series / No. 30 (2015): 123–134"
- [23] Air Quality Monitoring Committee (AQMC) (Constituted vide notification No. EN/3678(1-10)/3C-38/2018 Dated 05/12/2018), GOVERNMENT OF WEST BENGAL, "Comprehensive Air Quality Action Plan for Kolkata"
- [24] Dr. Indrajit Roy Chowdhury Assistant Professor, Jagadish Chandra Basu Sikshak Sikshan Mahavidyalaya, Kolkata, India, "Scenario of Vehicular Emissions and its Effect on Human Health in Kolkata City"
- [25] Centre for Science and Environment RIGHT TO CLEAN AIR CAMPAIGN, New Delhi 2011, "CITIZEN'S REPORT AIR QUALITY AND MOBILITY IN KOLKATA"

