



DESIGN ALTERATION AND IMPROVEMENT IN STRENGTH OF 2-WHEELER HAND BRAKE BY INVESTIGATING STATIC ANALYSIS AND REINFORCEMENT OF NATURAL COMPOSITE MATERIAL

AUSEKAR MAHEJABEEN ZULFIKAR, PROF. PANSARE VAIBAV.B., PROF. Surwase S.S.

1 (AUSEKAR MAHEJABEEN ZULFIKAR, M. E. SHRI TULJABHAVANI COLLEGE OF ENGINEERING, MECHANICAL ENGINEERING, TULJAPUR)

2 (PROF.PANSARE VAIBAV.B., SHRI TULJABHAVANI COLLEGE OF ENGINEERING, MECHANICAL ENGINEERING, TULJAPUR)

3 (PROF.SURWASE.S.S., SHRI TULJABHAVANI COLLEGE OF ENGINEERING, MECHANICAL ENGINEERING, TULJAPUR)

ABSTRACT- Hand brake levers are generally utilized in all car, which goes about as a linkage among tenant and brake component. Existing structure is by all accounts overdesigned. Strong displaying of same will be finished utilizing CATIA V5 programming. Limited component examination will be utilized to apply cantilever load Topology Optimization solver will be utilized to perform geography streamlining. Existing plan will at that point be machined according to topological improvement. weight decrease of Hand brake switch will be finished utilizing Glass fiber composite material for advanced model. static investigation of glass fiber hand brake switch will be performed utilizing ANSYS19 programming. Test testing will be approved utilizing UTM. Similar investigation will be finished with FEA and Experimental outcomes. End and future degree will be recommended.

Keywords— Hand Brake, UTM, CATIA, Optimization

I. INTRODUCTION

In the arrangement of street vehicles, the leaving brake, otherwise called the hand brake, crisis brake or e-brake, is utilized to keep the vehicle fixed and as a rule a crisis stop is additionally performed. Leaving brakes activity framework on more seasoned vehicles regularly comprise of a link associated with two wheel brakes toward one side and the opposite end to a pulling component which is worked with the driver's hand or foot. The instrument might be a hand-worked switch, at floor level close to the driver, or a straight draw handle situated close to the controlling section, or a (foot-worked) pedal situated next to the drivers leg. In many vehicles the leaving stopping mechanism process works just on the back wheels, which have diminished footing while at the same time slowing down. A few vehicles have the leaving brake on the front wheels, for example, most Citroens made since the finish of the Second World War and early models Saab 900. The most widely recognized use process framework for a leaving brake is to keep a vehicle unmoving when it is left. The stopping framework brake has a fastener or other locking instrument that will keep it connected with until physically discharged. On vehicles with programmed transmissions process framework, this is normally utilized working together with a leaving pawl in the transmission. An ongoing variety is the electric stopping brake. First introduced in the 2001 BMW 7 Series (E65), electric leaving brakes have since showed up in various vehicles.

Two varieties process framework are accessible: In the more-conventional "link pulling" type, an electric engine essentially pulls the stopping brake link on the press or pull of a catch rather In the lodge, as a mechanical pedal or handle. A progressively intricate unit (first observed on the 2003 Audi A8) utilizes a PC controlled engine connected to every one of the two back brake callipers alluded to as the Motor on Calliper(MoC) framework. Hand brake levers are cantilever structure utilized for moving movement from inhabitant to slow down instrument. Existing plan should be examined for mass improvement, subsequently decreasing in

general expense of brake levers. The destinations of this undertaking is to accomplish geography improved model for hand brake switch utilizing FEA and exploratory pressure investigation method. To draw 3 D model utilizing CATIA and to investigate hand brake utilizing ANSYS. To approve the outcomes.

The fundamental capacity of brake levers is to actuate the brake system, which permits individuals to back off or stop while they are riding a bicycle. There are two sorts of component: repairman brakes or water powered, and both working and viability are extremely extraordinary. Likewise, there are contrasts between all sort of modalities there are in the realm of biking, without considering in the event that they are pressure driven or repairman and distinctive sort of materials, contingent upon the nature of them. The working of brake levers is basic. On the off chance that we talk about a technician brake switch, above all else we have to push it. This activity extends a metallic rational that allows the two brake cushions put focus on one of the two-wheel edges. The working of water driven brakes is somewhat extraordinary. Here so as to stop the bicycle, the brake switch pushes exceptional oil making weight and making the bicycle delayed down or stop. The undertaking that brake levers need to do makes them to arrive at some fundamental properties. So they have hardness and solidness as well as gentility and obstruction. What's more, this has a straightforward clarification; these levers must have the option to help an amazingly hand-push without breaking or twisting, so they make feasible for individuals to hinder the bicycle with no risk



Fig. 2 wheeler hand brake

II. LITERATURE REVIEW

M.R. Mansor et al. [1] In this article writer portray about glass strands strengthened polymer composites material and car brake switch structure. Because of late pattern and expanding mindfulness towards supportable item plan, characteristic based fiber materials are increasing a recovery fame to supplant manufactured based fiber in the detailing of composites particularly for car basic and semi auxiliary applications. Improvement of car parts only from time to time requires the thought of three central point which are the segment geometrical structure determination, material choice and assembling process choice, most fundamentally in the early item configuration stage. Determination of the best regular fiber material to be hybridized with glass fiber fortified polymer composites for the structure of a traveler vehicle focus switch leaving brake segment was performed utilizing the Analytical Hierarchy Process (AHP) in light of the defined item plan particulars. Through the AHP technique, kenaf bast fiber was featured as the best competitor material which satisfies the structure destinations and execution prerequisites contrasted with the other recognized up-and-comer materials. Consistency examination was likewise performed to gauge the level of consistency for the outcomes got and the judgment made during the pair-wise correlation investigation. The last consistency proportion for the general chain of command system determined was seen as 0.00 which is inside the consistency proportion worthy range (under 0.10).

J.L. Santolaya et al. [2] In this paper creator chiefly engaged to configuration front brake handle for huge removal bikes. In a stopping mechanism that follows up on the front wheel of a bike is conceivable recognize three distinct parts (De Castro, 2001): the brake handle, which works the pilot with his correct hand, the pressure driven transmission and the unit shaped by the cylinders and the brake braces, which at last makes the power on the brake circles fixed to the wheel. This work centers around the plan of a brake handle, which is framed by two principle pieces: the switch and the ace chamber. This work shows the plan procedure of a front brake handle for enormous uprooting cruisers and depicts the subsequent component. We have utilized a technique that considers three principle perspectives: the compelling operability of the instrument, the sufficient adjustment to the rider who will follow up on it and the practicality of the turn of events and assembling process. The investigation of every one of these viewpoints mutually has been fundamental to accomplish a streamlined structure. The last structure of the instrument and the shapes and measurements of their parts permit getting an adequate increase of the pilot power to stop totally the cruiser in the most requesting cases. Furthermore, the plan can fit appropriately to the gloved right hand of the pilot and to offer more noteworthy customizability and slowing down control than an ordinary brake handle. Structure viewpoints to encourage production of the component have additionally been considering. Infusion embellishment of Al-Si amalgams was chosen as most appropriate procedure for acquiring the perplexing states of the segments and, simultaneously, for keeping up high creation rates.

M.R. Mansor et al. [3] This paper presents the calculated structure of kenaf fiber polymer composites car leaving brake switch utilizing the mix of Theory of Inventive Problem Solving (TRIZ), morphological outline and Analytic Hierarchy Process (AHP) techniques. The point is to create and choose the best idea plan of the part dependent on the item structure details with uncommon regard for consolidate the utilization of common fiber polymer composites into the segment plan. In this paper, the TRIZ inconsistency grid and 40 innovative standards arrangement apparatuses were applied in the early arrangement age stage. The standard arrangement boundaries for the particular plan qualities were later refined in subtleties utilizing the guide of morphological outline to efficiently create reasonable structures for the segment. Five imaginative plan ideas of the segment were created and AHP technique was at long last used to play out the multi-rules dynamic procedure of choosing the best idea structure for the polymer composite car leaving brake switch part. In ends, five (5) new idea structures for the kenaf fiber polymer composites car leaving brake switch were Fig. 10. Stress conveyance for idea structure 2. M.R. Mansor et al. /Materials and Design 54 (2014) 473–482

481 created utilizing the coordinated TRIZ–Morphological Chart–AHP strategy. The arrangement at applied plan stage was made conceivable by utilizing TRIZ strategy dependent on the TRIZ 40 creative standards approach with are division (#1), nearby quality (#3) and composite materials (#40) and the thought produced were additionally refined into explicit structure highlights utilizing the morphological outline.

Yvan Champoux et al. [4] This paper speaks to Dynamic adjustment of an instrumented bicycle brake hood in estimating power consumed by the hands. One of the most huge variables in ride quality in cycling sports are the vibrations produced by street surface imperfections going through the bike and sent to the cyclist's hands and backside. To examine comfort, one metric that has been advanced is the estimation of the force assimilated at the cyclist's hands. Estimating consumed power requires the utilization of the power and the speed at the hands and gives a general vitality based amount. The point of this examination is to progressively adjust an instrumented brake hood transducer to gauge the force assimilated at the cyclist's hands. Street cycling aficionados ride for periods totalling a few hundred hours out of every year. It is in this manner not astonishing that they are happy to pay extra to acquire an agreeable bicycle that can channel the best conceivable measure of street vibrations felt at the hands and posterior. In comfort appraisal concentrates in the vehicle business, speeding up is frequently used to measure vibration. Quickening is anything but difficult to quantify on the grounds that it only requires joining a little and promptly accessible transducer to the structure.

Zhaobo Qina et al. [5] In this paper creator portray about half and half followed vehicles. Cross breed followed vehicles have gotten progressively well known for rough terrain applications because of their better mileage and higher yield power. Right now, the most mainstream in the creation of followed vehicles are the arrangement half and half, due to the straightforward powertrain plans. In any case, they experience the ill effects of high vitality transformation misfortunes and huge drive engines. To defeat these issues, multi-mode half and half followed vehicles are utilized since they have high productivity and astounding in general execution. The proposed multi-mode cross breed powertrain can understand straight driving, turning, and driving in reverse with no extra controlling system. To efficiently investigate all the potential structures of multi-mode cross breed structures with planetary apparatuses, a geography control-size-incorporated improvement approach is introduced. A multi-mode power-split half and half powertrain utilizing numerous PGs and grasps may include a great many structures.

III. PROBLEM STATEMENT

Hand brake levers are cantilever structure used for transferring motion from occupant to brake mechanism. Existing design needs to be investigated for mass optimization, hence reducing overall cost of brake levers.

1. To prepare CAD design of exist hand brake lever using CATIA V5.
2. To perform static analysis of hand brake lever using ANSYS19.
3. To investigate result of load on stress, displacement and Strain hand brake through finite element analysis.
4. Optimization of exist hand brake lever by using glass fiber composite material.
5. Experimental stress analysis of hand brake using Strain gauging & load applied through UTM
6. Comparative analysis between FEA & Experimental results.

IV. METHODOLOGY

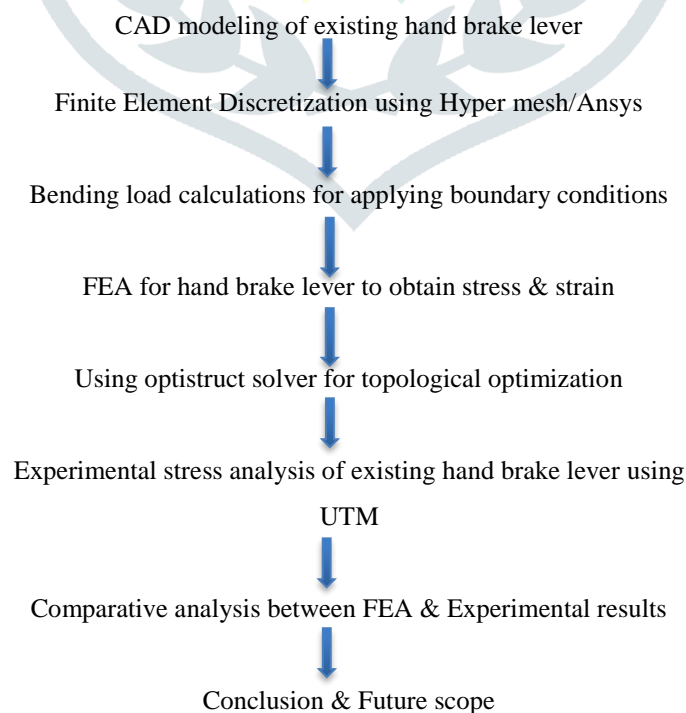

V. CATIA MODEL

Three-dimensional model of existing hand brake lever was making in Catia V5 R20 software.

i. Existing design

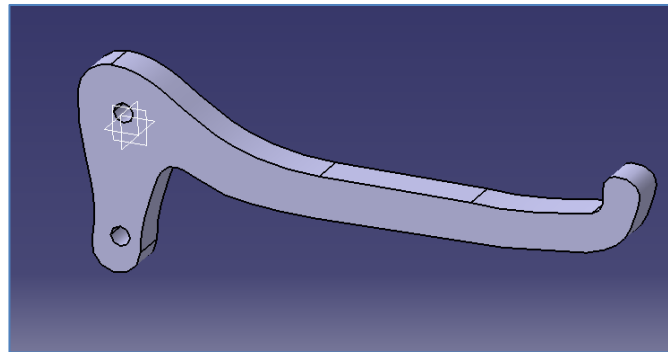

Fig. Existing cad model

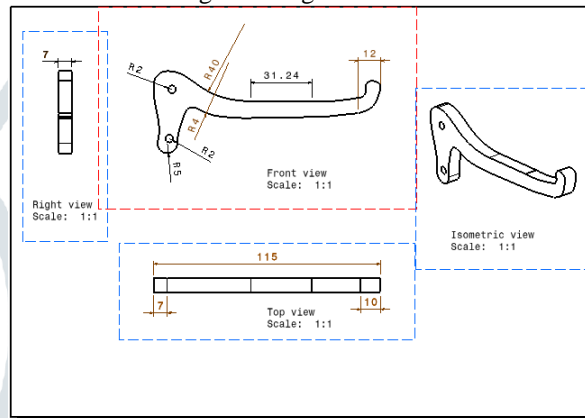

Fig. Drafting of existing model

ii. FEA ANALYSIS OF WHEEL HUB IN ANSYS

Material Selection – aluminum alloy

Properties of Outline Row 3: Aluminum Alloy NL		
A	B	C
Property	Value	Unit
Material Field Variables	Table	
Density	2770	kg m ⁻³
Isotropic Elasticity		
Derive from	Young's Modulus and Po...	
Young's Modulus	7.1E+10	Pa
Poisson's Ratio	0.33	
Bulk Modulus	6.9608E+10	Pa
Shear Modulus	2.6692E+10	Pa

Table 1 Material properties

a. MESH

ANSYS Meshing may be a general-purpose, intelligent, automated high-performance product. It produces the foremost appropriate mesh for accurate, efficient Multiphysics solutions. A mesh compatible for a selected analysis are often generated with one click for all parts during a model. Full controls over the choices want to generate the mesh are available for the expert user who wants to fine-tune it. the facility of multiprocessing is automatically wont to reduce the time you've got to attend for mesh generation.

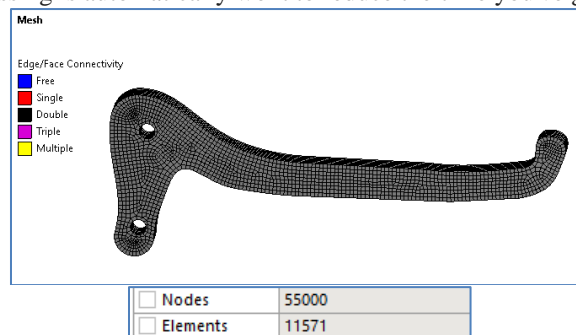

Nodes	55000
Elements	11571

Details of "Body Sizing 2" - Sizing	
Scope	
Scoping Method	Geometry Selection
Geometry	1 Body
Definition	
Suppressed	No
Type	Element Size
Element Size	2.0 mm
Advanced	
Defeature Size	Default
Behavior	Soft
<input type="checkbox"/> Volume	9.9859 cm ³
<input type="checkbox"/> Mass	27.661 g

Fig. Meshing

b. Boundary Condition

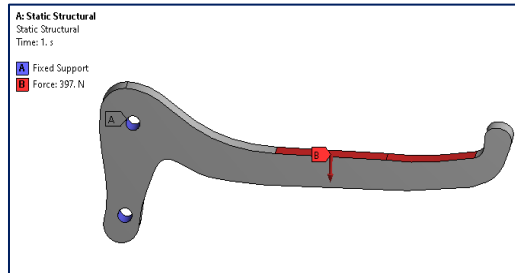

Fig. Boundary condition

c. Results

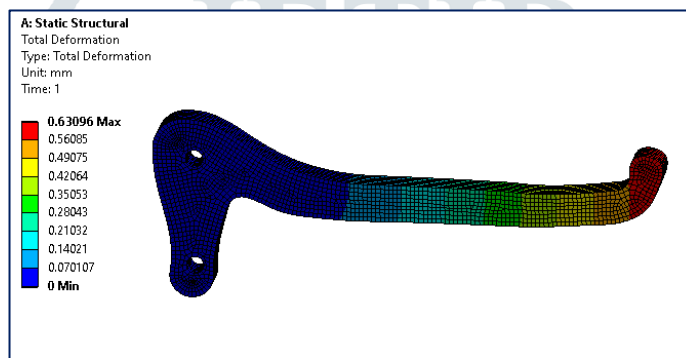

Fig. Total deformation

- Maximum deformation under static condition of steering upright 0.63 mm is observed.

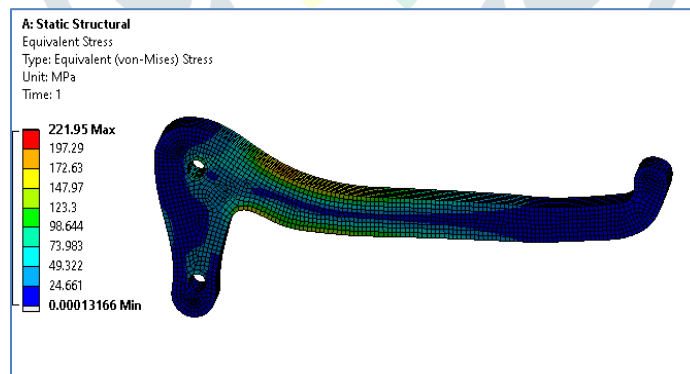

Fig. Equivalent stress

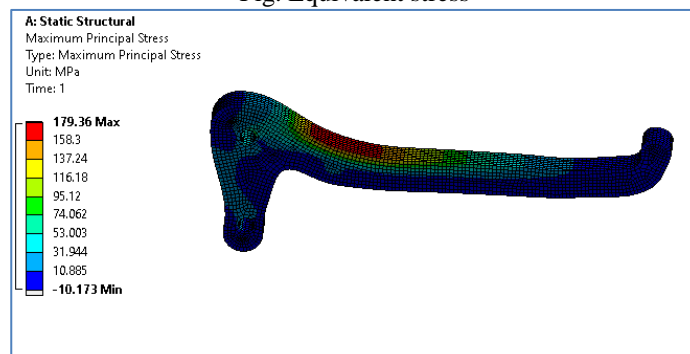

Fig. Maximum principal stress

iii. TOPOLOGY OPTIMIZATION

Topology optimization may be a mathematical approach that optimizes material layout within a given design area, for a given set of loads and boundary conditions such that the resulting layout meets a prescribed set of performance targets.

a. Basic Theory

There are three kinds of structure optimization,

- Size optimization
- shape optimization
- Topology optimization

Three optimization ways that correspond to the three stages of the product design methodology, significantly the detailed design, basic design and conceptual design. Size optimization keeps the structural form and topology structure invariant, to optimize the various parameters of structure, like thickness, section size of beam, materials properties; shape optimization maintains the topology structure, to vary the boundary of structure and form, search for the foremost applicable structure boundary scenario and shape; topology optimization is to hunt out the most effective path of materials distribution throughout never-ending domain that meet the displacement and stress conditions in structure, produce a selected performance optimum. Thus, compared to size and shape optimization, topology optimization with more freedom degree and larger design area, its greatest feature is below unsure structural form, in keeping with the well-known condition and a given load to figure out the cheap structure, every for the abstract variety of recent product and improvement design for existing product, it's the foremost promising side of structural optimization. For continuous structure topology optimization, there are some mature ways like: uniform technique, evolutionary structural optimization technique, variable density technique etc. Uniform technique introduced cell structure of micro structure (unit cell) at intervals the elements of the structure, each unit has three forms, significantly non-material voids (size = 1), isotropic-material entity medium (size = 0) and orthotropic-material opening-hole medium ($0 < \text{size} < 1$). whereby the distribution of each form are able to describe the form of topology and conjointly the form of structure; evolutionary structural optimization technique believe that stress in any elements of the structure should beneath the identical level in an ideal structure. which suggests the native material with a low stress state isn't entirely used, thus you'll be able to delete the material artificially. thus bit by bit remove material that in a low stress state, then delete the update rate, thus optimized structure becomes more uniform. Variable density technique is used to conduct optimization throughout this paper

b. BOUNDARY CONDITIONS FOR TOPOLOGY OPTIMIZATION

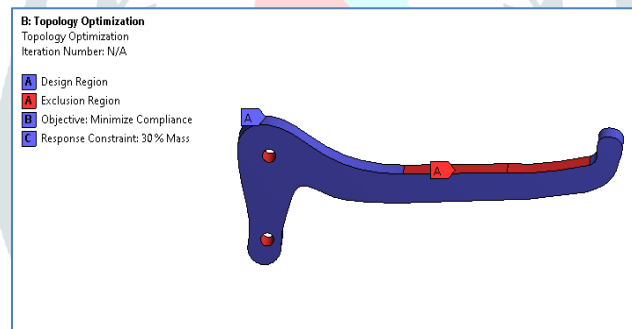

Fig. Topology optimization

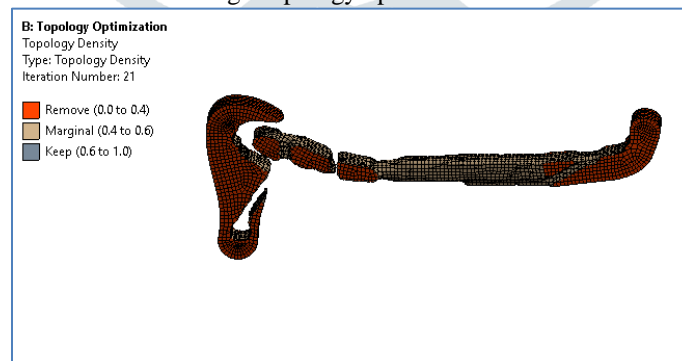

Fig. Topology density

- Red region indicates material removal area from existing model

In boundary condition non design area indicated in red region include the boundary condition in static structural analysis and design area is indicated in blue region.

Topology optimization is performed after static structural analysis with existing boundary condition to determine material removal area. After, performing topology optimization red region indicates the material removal area from which material can be removed as per our need. So, in our case original mass is 7.04 kg but removal of material is about 55 % which lead to 4.03 kg as per software. But it depends on us to removal of material by proper design and reanalysis as per existing conditions to sustain boundary condition.

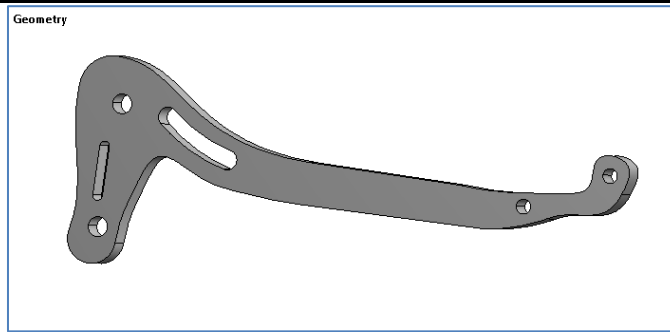
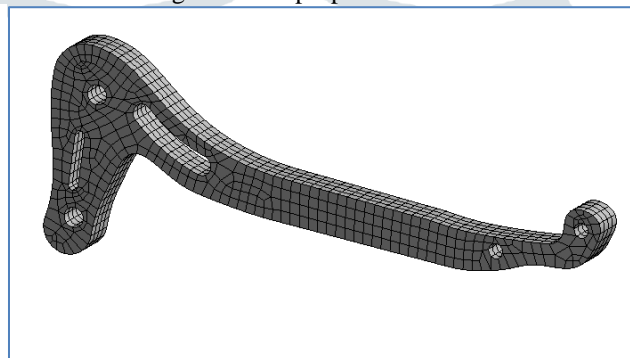

Fig. Optimized design

Properties of Outline Row 3: Aluminum Alloy			
	A	B	C
1	Property	Value	Unit
2	Material Field Variables	Table	
3	Density	2770	kg m ⁻³
4	Isotropic Secant Coefficient of Thermal Expansion		
6	Isotropic Elasticity		
7	Derive from	Young's Modu...	
8	Young's Modulus	7.1E+10	Pa
9	Poisson's Ratio	0.33	
10	Bulk Modulus	6.9608E+10	Pa
11	Shear Modulus	2.6692E+10	Pa

Fig. Material properties



Statistics	
<input type="checkbox"/> Nodes	8948
<input type="checkbox"/> Elements	1572

Details of "Body Sizing" - Sizing	
<input type="checkbox"/> Scope	
Scoping Method	Geometry Selection
Geometry	1 Body
<input type="checkbox"/> Definition	
Suppressed	No
Type	Element Size
<input type="checkbox"/> Element Size	2.0 mm

Fig. Meshing

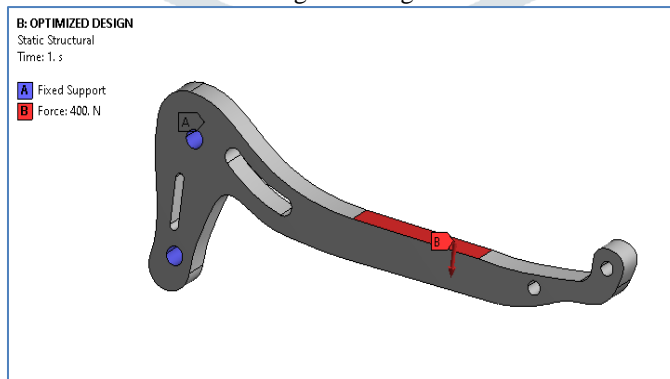

Fig. Optimized design boundary condition

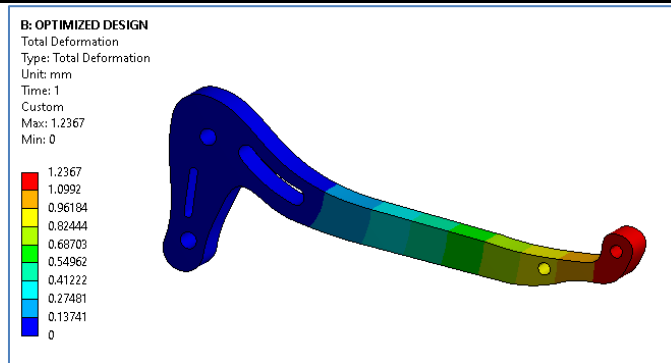

Fig. Optimized design deformation result

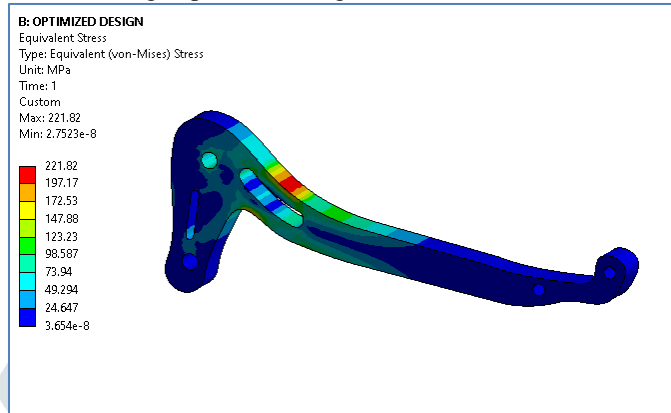

Fig. Optimized design equivalent stress result

c. TOPOLOGY OPTIMIZED DESIGN WITH REINFORCED GLASS EPOXY



Fig. layer section in optimized design

Layer	Material	Thickness (mm)	Angle (°)
(+Z)			
3	Epoxy E-Glass UD	1	0
2	Epoxy E-Glass UD	1	0

- To improve topology optimized design, it is reinforced with glass fibre epoxy reinforcement

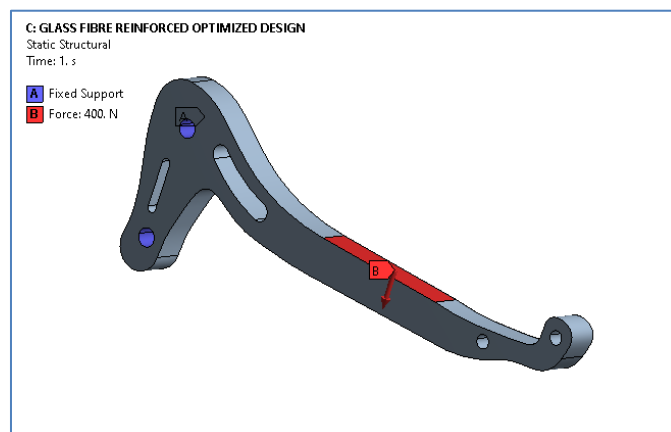

Fig. Boundary condition

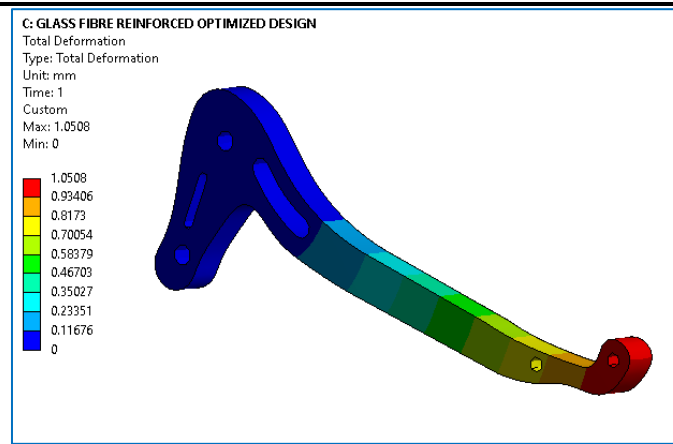

Fig. total deformation

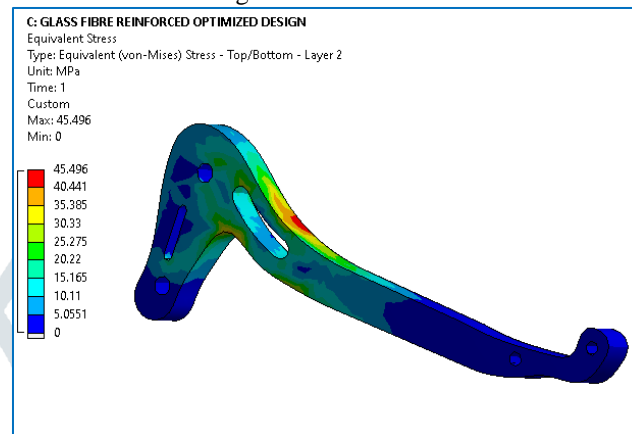

Fig. Equivalent stress by layer 2

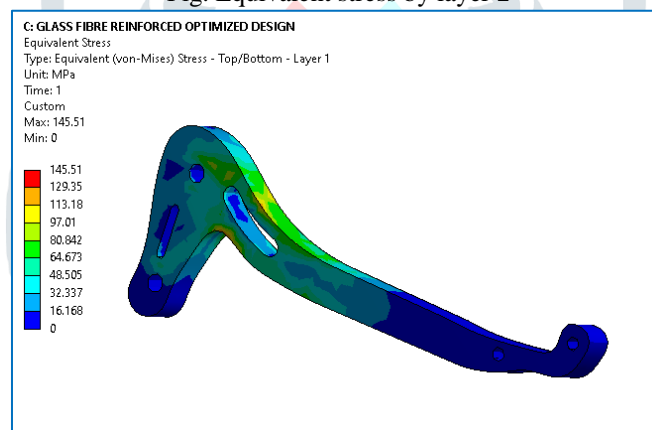

Fig. Equivalent stress by layer 1

VI. EXPERIMENTAL SETUP

A universal testing machine (UTM), also known as a universal tester, materials testing machine or materials test frame, is used to test the tensile strength and compressive strength of materials. An earlier name for a tensile testing machine is a tensometer. The "universal" part of the name reflects that it can perform many standard tensile and compression tests on materials, components, and structures (in other words, that it is versatile). The set-up and usage are detailed in a test method, often published by a standards organization. This specifies the sample preparation, fixturing, gauge length (the length which is under study or observation), analysis, etc. The specimen is placed in the machine between the grips and an extensometer if required can automatically record the change in gauge length during the test. If an extensometer is not fitted, the machine itself can record the displacement between its cross heads on which the specimen is held. However, this method not only records the change in length of the specimen but also all other extending / elastic components of the testing machine and its drive systems including any slipping of the specimen in the grips. Once the machine is started it begins to apply an increasing load on specimen. Throughout the tests the control system and its associated software record the load and extension or compression of the specimen.

a. Specification of UTM

1	Max Capacity	400KN
2	Measuring range	0-400KN
3	Least Count	0.04KN
4	Clearance for Tensile Test	50-700 mm
5	Clearance for Compression Test	0- 700 mm
6	Clearance Between column	500 mm
7	Ram stroke	200 mm
8	Power supply	3 Phase , 440Volts , 50 cycle. A.C
9	Overall dimension of machine (L*W*H)	2100*800*2060
10	Weight	2300Kg

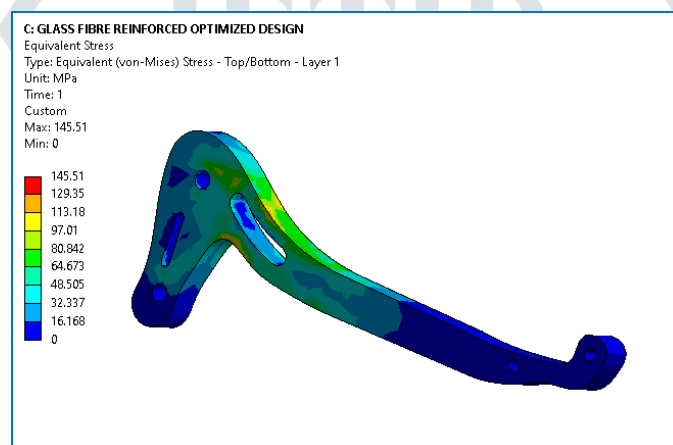

Fig. Experimental testing stress results

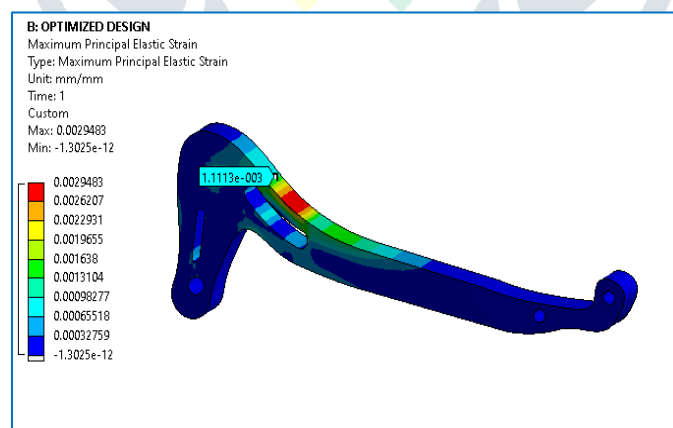

Fig. Experimental testing strain results

By FEA analysis strain is observed around 1111 micron.

b. Experimental procedure

- Fixture is manufactured according to component designed.
- Single force is applied as per FEA analysis and reanalysis is performed to determine strain by numerical and experimental testing.
- Strain guage is applied as per FEA results to maximum strained region and during experimental testing force is applied as per numerical analysis to check the strain obtained by numerical and experimental results.
- During strain gage experiment two wires connected to strain gage is connected to micro controller through the data acquisition system and DAQ is connected to laptop. Strain gage value are displayed on laptop using DEWESOFT software.



Fig. Experimental results

VII. ACKNOWLEDGMENT

The authors would like to thank the publishers and researchers for making their resources available. We also thank the college authority for providing the required infrastructure and support.

VIII. CONCLUSION

- Static structural analysis of 2-wheeler hand brake is performed to determine deformation and equivalent stress. It is observed that around maximum deformation is 0.63 mm and equivalent stress is 221.95 MPa. An optimized model is obtained from topology optimization technique.
- It is concluded that the region indicated in red region in topology optimization provides information regarding removal of material from that area. In our case original mass is 27.661 g but removal of material is to 24.62 gram as per software. But it depends on us to removal of material by proper design and reanalysis as per existing conditions to sustain boundary condition.
- Static structural analysis of 2-wheeler hand brake optimized model is performed to determine deformation and equivalent stress. It is observed that around maximum deformation is 1.23 mm and equivalent stress is 221.82 MPa.
- Weight reduction of around 10.99 % is observed along with strain measurement of 1111 microns and 1136 microns by numerical and experimental testing respectively.
- To improve topology optimized design, it is reinforced with glass fibre epoxy reinforcement. So Static structural analysis of 2-wheeler hand brake optimized model with glass fiber reinforcement is performed to determine deformation and equivalent stress. It is observed that around maximum deformation is 1.05 mm and equivalent stress is 145.51 MPa.

REFERENCES

- [1] "Hybrid natural and glass fibers reinforced polymer composites material selection using Analytical Hierarchy Process for automotive brake lever design" by M.R. Mansor , S.M. Sapuan, E.S. Zainudin, A.A. Nuraini, A. Hambali.
- [2] "Design of a Hydraulic Front Brake Handle for Large Displacement Motorcycles" by J.L. Santolaya, J. Sevil, R. Miralbés.
- [3] "Conceptual design of kenaf fiber polymer composite automotive parking brake lever using integrated TRIZ–Morphological Chart–Analytic Hierarchy Process method" by M.R. Mansor, S.M. Sapuan , E.S. Zainudin , A.A. Nuraini , A. Hambali.
- [4] "Dynamic calibration of an instrumented bike brake hood in measuring power absorbed by the hands" by Yvan Champoux, Joachim Vanwallenghem , Jean-Marc Drouet.
- [5] "Simultaneous optimization of topology, control and size for multi-mode hybrid tracked vehicles" by Zhaobo Qina,b , Yugong Luoa , Weichao Zhuangc , Ziheng Panb , Keqiang Lia,* , Huei Pengb
- [6] "Brake torque analysis of fully mechanical parking brake system: Theoretical and experimental approach" by Mohd-Razmi Ishak, Abd-Rahim Abu Bakar, Ali Belhocine, Jamaludin-Mohd Taib, Wan-Zaidi Wan Omar.
- [7] "Conceptual design of a polymer composite automotive bumper energy absorber" by M.M. Davoodi, S.M. Sapuan *, R. Yunus.
- [8] "Effect of the braking pressure variation on disc brake squeal of a railway vehicle: Test measurement and finite element analysis" by G.X. Chen, J.Z. Lv, Q. Zhu, Y. He, X.B. Xiao.