

# Review on Ducts for Diffuser Augmented Wind Turbine

Sandip Shinde<sup>#1</sup>, Mohit Malpani<sup>#2</sup>, Karan Kankaria<sup>#3</sup>, Nitishranjan Kund<sup>#4</sup>, Jayant Patil<sup>#5</sup>

<sup>#</sup>Mechanical Department, Savitribai Phule Pune University, Pune, India

**Abstract**— The paper describes the development of ducted wind turbines which harness wind energy more efficiently than a conventional wind turbine. It consists a brief discussion on different ducted turbine designs, their advantages and shortcomings. These designs include Invelox which operates in varying wind conditions, Wind tamer specifically designed for low cut in speeds, Ogin (FloDesign) turbine which utilizes a mixer-ejector shroud for accelerated flow of air particles, Buoyant turbine which is an airborne wind turbine, Skywolf turbine which is under the class of hybrid turbine. The current trend in wind power industry is presented along with a section of likely future development and application of ducted wind turbines.

**Keywords**— Ducted wind turbine, Betz Limit, Wind-lens turbine, Diffuser augmented wind turbine

## I. INTRODUCTION

World trend suggests a transition towards renewable energy technologies that offer an environmental solution to the problem of depletion of petroleum that's hovering over the planet. Wind Energy, as an alternative to burning fossil fuels, is plentiful, renewable, widely distributed, clean, produces no greenhouse gas emissions during operation, consumes no water, and uses little land. The net effects on the environment are far less problematic than those of fossil fuel sources.

Wind energy harnessing technologies are a large part of the renewable energy sector, and as such have been the focus of a great deal of research in the last couple of decades. Developing efficient and cost-effective wind turbines for the urban environment is a new area of application that can further reduce dependency on fossil fuels thus reducing greenhouse gas emission. In addition, the ability to provide energy at close proximity to demand, as well as reducing the cost associated with power distribution as a result makes urban wind power a very attractive energy source. The main challenge is integrating wind turbines in complex urban built-environment and building aerodynamics. It is well known that wind power increases with the cube of wind velocity, i.e. advantage of the locally increased density and velocity of the airflow. However, the unavoidable reduction of mean flow due to the increased ground roughness (friction) and the unpredictable - and often changing direction of air movement, i.e. wind, within urban areas result in a very turbulent flow, which leads to inefficient wind turbines. Therefore, the design of efficient and effective wind turbines, which can operate under these conditions, becomes critical for performance optimization.

Due to the large growth of the wind power industry many different wind turbine designs exist are in current development, or have been proposed due to their unique features. Two such primary turbines being VAWT (Vertical Axis Wind Turbine) and HAWT (Horizontal Axis Wind Turbine). An innovative and evolved version being the DWT (Ducted Wind Turbines). The wide variety of designs reflects ongoing commercial, technological, and inventive interests in harvesting wind resources both more efficiently and to the greatest extent possible, with costs that may be either lower or greater than conventional designs.

The idea of ducted wind turbines is to construct a nozzle type shroud or a conduit around a conventional wind turbine to adjust the airflow in order to raise the power extraction efficiency. In its early stage of development, the design usually featured a large inlet to absorb more wind. Eventually it became impractical since the duct usually increased the cost of the project significantly. However, smaller and cheaper designs are continuously introduced along with the rapid evolvement of aerodynamics, and they mostly handle the common function to induce more velocity rather than more airflow, which results from the fact that the dynamic energy of the wind is proportional to the cubic of its velocity.

## II. VARIOUS DUCTED WIND TURBINES

### A. InveloxTurbine

Patented by Sheerwind, INVELOX meaning increased velocity, uses a funnel to direct high velocity wind towards a venturi where the flow is accelerated. This accelerated flow can be harnessed by a single turbine or up to 3 turbines arranged one behind the other in a straight line [1].

All three turbines were placed simultaneously in a duct and tested under the same input, environmental, and load conditions. Fig.1(a) shows the voltage output of the generator for each of the three wind turbines measured individually and their combined voltage. The power output of each turbine when operated individually as a function of the turbine rotational speed (rpm) is plotted in Fig.1(b). Similarly, the outcomes of testing two turbines simultaneously are displayed in Fig. 2. By comparing these results with the output when all the three turbines are tested individually (shown in Fig. 3), it is clearly seen that there is significant increase in output power and voltage when all the three turbines are utilized. [2]

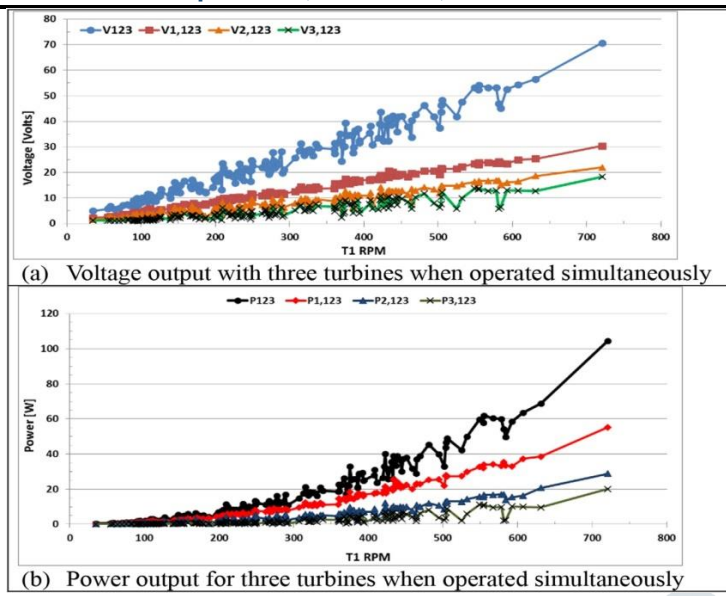

Fig. 1. Voltage and power output of each of the wind turbines operated simultaneously under similar conditions, V123 or P123 1/4 total voltage or power, Vi,123 or Pi,123 1/4 voltage or power of the  $i^{th}$  turbine measured while all three operating.

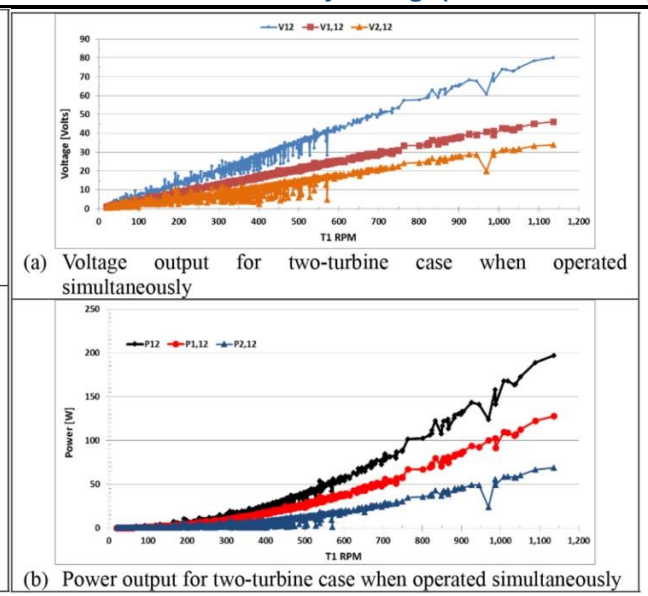

Fig. 2. Voltage and power output of each of the wind turbines operated simultaneously under similar conditions, V12 or P12 1/4 total voltage or power, V1,12 or P1,12 1/4 voltage or power of the first turbine measured while both running, V2,12 or P2,12 1/4 voltage or power of the second turbine measured while both are running.

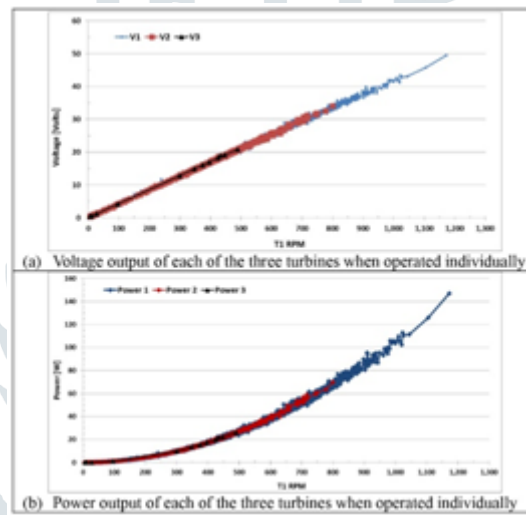

Fig. 3. Voltage and power output of each of the wind turbines operated individually under similar conditions.

According to the CFD analysis, there is a threefold increase in the velocity of wind while it is funnelled and passed through the venturi. The ducted turbines have a higher efficiency of operation due to obvious reduction in tip-vortex losses. Additionally, the omni-directional intake gives it the ability to capture wind even after change in its direction, without using complicated gear drives and wind direction sensing devices. Reduction in tip vortices, in turn, reduces the noise generated by the turbine's operation which is further dampened by the ducted enclosure. On the other hand, the apparatus can be set up aesthetically, by using architectural designs to enclose the ducts, making it more compatible with a residential locality. In addition to the above benefits, INVELOX does not harm birds or cause any radio interference as opposed to conventional wind turbines.

INVELOX has a detachable intake which enables us to remove and change the intake funnel to suit the wind conditions of different locations. It is possible for us to design INVELOX with speed ratio of 6 or more by attaching different designs of inlet manifolds. This design allows us to harness wind energy at wind speeds as low as 1 m/s by accelerating it to 4m/s. Hence, urban environments can also produce appreciable amount of energy.

## B. Wind Tamer Turbine

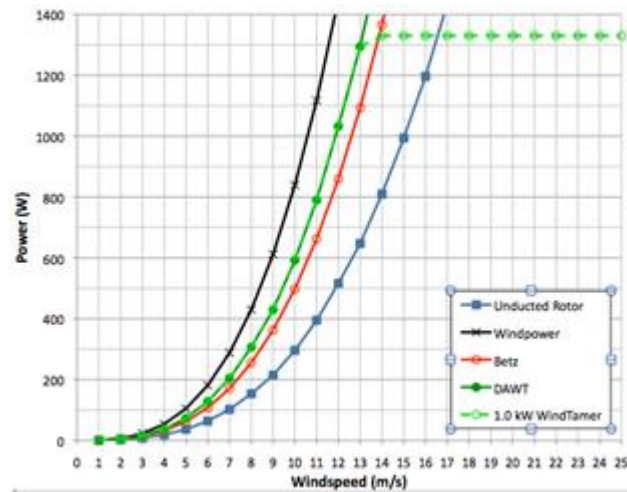

Fig. 4. WindTamer Power Curve Behavior, 52inch rotor

Research conducted by Clarkson university [3], New York on a wind tamer turbine of rotor diameter 52"- 172" indicated that the turbine could generate power exceeding the theoretical limit of 59.3% i.e. the Betz limit. A coefficient of performance of 0.6- 0.8 was reached. Hence it could develop twice the power of a conventional wind turbine.

The structural design of a wind turbine consists of a multi-blade rotor (10-12 blades) which are mounted in a diverging duct. The duct creates a suction pressure at the rear end of the blade due to its shape. To further increase the suction, a step is provided at the end of the duct which helps in controlled mixing of outer and inner airstreams. The step is provided with fins which helps in the creation of vortices perpendicular to the axis of the turbine. These vortices result in increased velocity and decreased pressure at the end of duct. Due to the creation of these two phenomena occurring simultaneously, the mass flow rate of wind crossing the rotor increases. This results in the increase of wind power available to harness.

Tests were conducted on a 52" rotor turbine, for which a mobile test rig was developed. The hub height was approximately 13 feet off the ground. Tests were conducted at wind speeds varying from 4-8 m/s.

## C. Skywolf Turbine

Skywolf turbine comes under class of turbine known as hybrid turbines. The turbines that falls under this category are provided with additional provision to harness solar energy. The housing includes divergent frame members, central support members and outer plates. Air passages are created underneath the arcuate outer plates. A cowling is attached to the end plates.

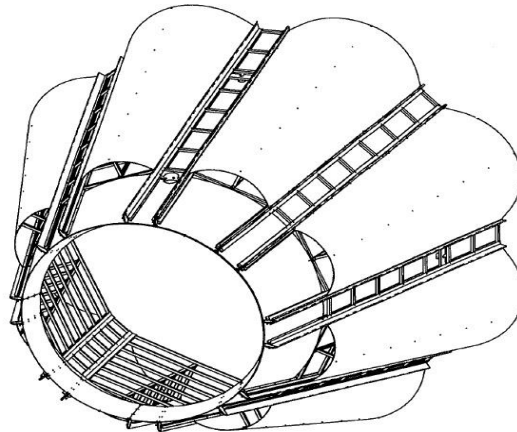

Fig. 5. Shroud of Skywolf turbine [4]

The setup is similar to conventional wind turbine with only addition of shroud. This shroud serves the purpose of increasing the pressure difference across the turbine and providing projections on which the photovoltaic cells can be attached to. The increased pressure difference increases the airflow velocity which in turn increases the power generated.

D. Ogin (FloDesign) Turbine

The company’s design, which draws on technology developed for jet engines, circumvents a fundamental limit to conventional wind turbines. Typically, as wind approaches a turbine, almost half of the air is forced around the blades rather than through them, and the energy in that deflected wind is lost. At best, traditional wind turbines capture only 59.3 percent of the energy in wind, a value called the Betz limit.

FloDesign surrounds its wind-turbine blades with a shroud that directs air through the blades and speeds it up, which increases power production. The new design generates as much power as a conventional wind turbine with blades twice as big in diameter. The smaller blade size and other factors allow the new turbines to be packed closer together than conventional turbines, increasing the amount of power that can be generated per acre of land.

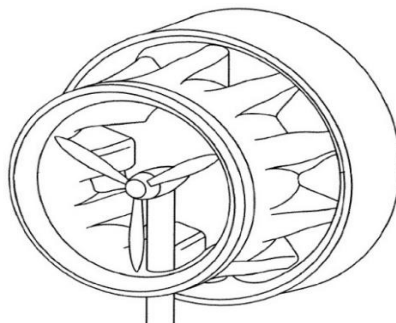

Fig. 6. Ogin Turbine [5]

The idea of enshruding wind-turbine blades isn’t new. But earlier designs were too big to be practical, or they didn’t perform well, in part because the blades had to be very closely aligned to the direction of the wind. The new blades are smaller and can work at angles of up to 15 to 20 degrees away from the direction of the wind.

E. Buoyant Turbine

Operating on the principle similar to conventional wind technology, Airborne wind energy exploits high altitude winds (at an altitude of 200–10,000 m) by a tether-controlled turbine/aircraft, thus taking the advantage of powerful consistent winds while evading the expenses of tower construction. The electrical generator is either attached to airborne wind turbine or operates at the ground. Economical wind energy can be supplied to remote communities, off-grid industries, and disaster emergencies. Additionally, it offers the opportunity of installation at logistically challenging sites and advantage of reduced impacts on the landscape. The Airborne Wind Energy (AWE) systems are usually distinguished as Ground-Gen systems and Fly-Gen systems based on the location of the generator [6]. In Ground-Gen AWE (GG-AWE), the generator is fixed on the ground and electricity is generated in intermittent phases of production and recovery by exploiting the aerodynamic forces of the aircraft. The examples of GG-AWE systems are Buoyant rotating cylinders, Magnus effect-based airborne, high altitude parachute, gliders and kites. Whereas in Fly-Gen system (FG-AWE) or on-board generator system, the generator is attached to a wind turbine and production of electrical energy takes place on-board. FG-AWE systems are further classified as cross-wind mode tethered aircraft turbine, and non-crosswind harvesting quadcopter, Magnus-effect and buoyant airborne wind turbines.

The Buoyant Airfoil Turbine (BAT) is a recently introduced technology which uses a helium filled shell that envelopes the turbine and keeps it afloat at high altitudes [7]. A research on aerofoils by varying the camber and maximum thickness has been studied using a k-omega SST. The highest coefficient of performance for the turbine blade. The lift generated by the aerofoil points towards the centre of the shell, thus no net lift is generated. However, an increase in circulation due to pressure difference results in an additional increase in the airflow through the turbine [8].

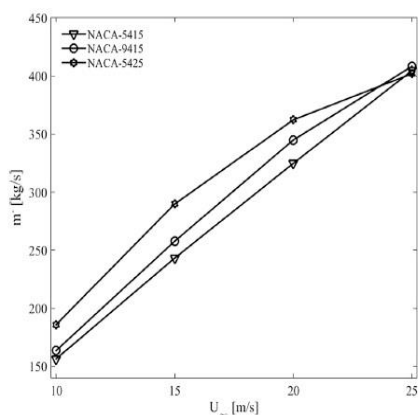

Fig. 7. Effect of shell profiles on the swallowed mass flow by rotor.

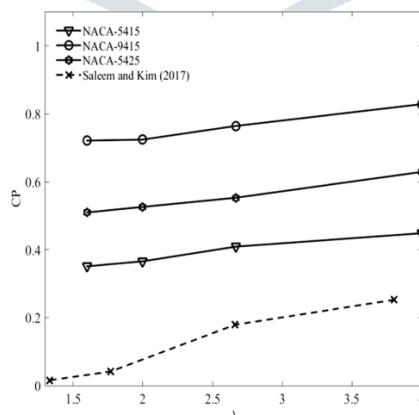

Fig. 8. Power coefficient of different airborne wind turbines in shell configuration.

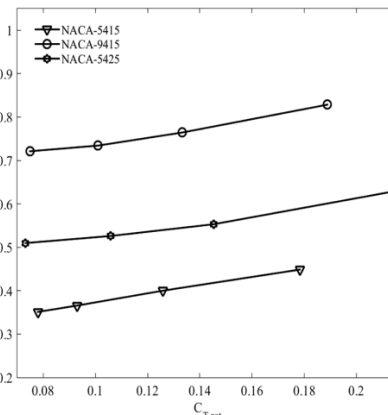

Fig. 9. Effect of buoyant shell on the power coefficient

In a test comparing NACA 5415, NACA 9415 and NACA 5425 aerofoils, NACA 5425 showed the highest mass flow rate as is shown in Fig. 7. NACA 9415 showed the highest duct thrust coefficient (0.6-0.7) whereas NACA 5425 showed the highest rotor thrust coefficient (around 0.2 at tip speed ratio 4). Fig. 8 represents turbine power coefficient variation with rotor tip speed ratio for all the considered shell configurations. The power coefficients for tip speed ratio of 4 were 0.8, 0.6 and 0.4 for NACA 9415, NACA 9425 and NACA 9425 respectively whereas that for simple diffuser shaped duct was 0.2. It is also evident from Fig. 9 that either increase in camber (NACA-9415) or profile thickness (NACA-5425) results in power coefficient enhancement as compared to the reference profile (NACA-5415).



### III. LIMITATION

The small and medium size ducted wind turbines have not been able to meet the energy requirements. Even in case of a large turbines, applying a duct to turbines with big rotors is impractical since the duct's chord length should be about twice the rotors radius to increase the wind velocity.

### IV. FUTURE DEVELOPMENTS

The unit cost of producing electricity by modern ducted turbines is equivalent to that produced by conventional means. This statistic showcases the need to enhance the power output as well as efficiency of wind turbines for a successful adoption of wind turbines in power industry.

Airborne Wind Turbines are the next step in wind power generation as they have a higher flexibility in installation and higher wind speeds are accessible. Mastering the aerodynamics to perfecting the design to creating from scratch an entire manufacturing process and global supply chain.

As the wind industry has grown, its turbines have gotten bigger too—so large that a few offshore turbines now top 500 feet in height and cover a 400-foot diameter in the sweep of their rotor blades. Larger is the trend can generate huge amounts of electricity at extremely low costs. Size can have some drawbacks: Big turbines are a challenge to engineer, build, transport, and install. They can also be too noisy and imposing to go in populated areas.

Research in the field of creating extremely light and larger blades specifically designed for DAWT application is required. Durable tether construction that can transmit electricity without posing risk to its environment also needs to be designed.

### ACKNOWLEDGMENT

We wish to acknowledge the continued support and valuable guidance provided by the Dr. N. P. Sherje (Head of Department) and Prof. S.P. Shinde. Also, we would like to thank all those people who helped in making this review paper.

### REFERENCES

- [1] Daryoush Allaei et al., "INVELOX: Description of a new concept in wind power and its performance evaluation" *Energy* 69 (2014) 336-344
- [2] Daryoush Allaei et al., "INVELOX with multiple wind turbine generator systems", *Energy* 93 (2015) 1030-1040
- [3] K.D. Visser, "Wind Tamer Turbine Performance Report", Clarkson University, Potsdam, NY 13699-5725
- [4] SkyWolf Wind Turbine Corp., "Housing for a High Efficiency Wind Turbine", US 9,322,391 B2, Apr. 26, 2016. (Skywolf)
- [5] Presz, JR. et al., "Fluid Turbine", US 2011/0189007 A1, Aug. 4, 2011. (OginFlodeSIGN)
- [6] Antonello Cherubini et al., "Airborne Wind Energy Systems: A review of the technologies", *Renewable and Sustainable Energy Reviews* 51(2015) 1461–76
- [7] Arslan Saleem, Man-Hoe Kim, "Performance of buoyant shell horizontal axis wind turbine under fluctuating yaw angles", *Energy Conversion and Management* 177 (2018) 233–248
- [8] Arslan Saleem, Man-Hoe Kim, "Aerodynamic analysis of an airborne wind turbine with three different aerofoil-based buoyant shells using steady RANS simulations" *Energy Conversion and Management* 177 (2018) 233–248