

A High Accuracy Solver for RTE in Underwater Optical Communication Path Loss Prediction

¹K.Mohana krishna, ²K.Sai Sri Varshini, ³N.Chandana, ⁴M.Naga Sruthi, ⁵P.Chandana

¹Assistant Professor, Dept. Of E.C.E

^{1,2,3,4,5,6}Geethanjali Institute of Science and Technology, Gangavaram, Nellore Dist.

Abstract

In this paper, we present another improved numerical structure to assess the time-subordinate radiative transfer equation (RTE) for underwater optical wireless communication (UOWC) frameworks. The RTE predicts the optical way loss of light in an underwater channel, as a function of the inalienable optical properties (IOPs) identified with the water type, to be specific the absorption and scattering coefficients just as the phase scattering function (PSF). We achieve the reenactment execution dependent on an improvement of the limited distinction plot proposed in [1] just as an upgrade of the quadrature technique expecting to figure the necessary term of the RTE [2]. Furthermore, we assess the got power at the collector plane in three measurements by thinking about a given beneficiary opening and a field of view (FOV). At long last, we assess the UOWC framework's bit mistake rate execution metric as a function of the spread separation, and time.

I. INTRODUCTION

Lately, we saw a critical increment of the human exercises in the underwater investigation. As a matter of fact, with the worldwide atmosphere issues on the planet, just as the modern and military purposes, there have been a major enthusiasm for the arrangement of sea investigation and communication frameworks [3], [4]. Underwater imparting gadgets, for example, wireless sensors and floats require a dependable communication connect so as to trade a tremendous measure of data between them. The conventional RF communication innovation dependent on transporter balanced signs experiences very extreme weakening at high frequencies, which confines its communication go into a couple of meters [5]. Also, since seawater contains a ton of salt, which is a conductive transmission medium, RF electromagnetic waves can proliferate just a couple of meters, making it not a reasonable answer for such communication frameworks [4]. Then again, acoustic communication is the most profoundly conveyed innovation these days in the underwater communication frameworks [6]. It might give an any longer transmission interface run in underwater conditions contrasted with the RF joins (i.e., up to 20 km) [7]. Notwithstanding, because of the low proliferation celerity of the sound wave in the water, i.e., 1500 m/s at unadulterated water, the acoustic connection experiences genuine communication delays called inactivity [8]. The acoustic innovation gives a bandwidth of many kilohertz, and thus, the related communication information rate is generally low (in the request of Kbps). In addition, acoustic handsets are substantial, expensive and vitality expending [4].

Optical wireless communication (OWC) is a promising innovation that begun drawing in the examination network amid the most recent three decades. It comprises on transmitting the data motions as light tapered bars utilizing LED or Laser gadgets through the free space [9]. Because of its incredible potential for giving a colossal measure of bandwidth, protection from water interface weaknesses, and high security, OWC is the most supported arrangement into furnishing a low-inactivity communication connect with information rates of many Gbps over moderate separations [10]. When all is said in done, two wonders degenerate the light engendering in the underwater conditions, to be specific light absorption and scattering, which are the two noteworthy Inherent Optical Properties (IOPs) that decides light power misfortune [11]. Absorption is characterized as a procedure where the photons lose their vitality and convert it into another structure, for example, substance or warmth, while scattering alludes to the vitality misfortune because of the light communication with the medium atoms and particles [11]. It is vital that the more noteworthy are the scattering and absorption coefficients, the vital is the power misfortune in the medium. So as to break down and foresee the all out light power misfortune in the underwater medium, a few methodologies have been associated with this specific circumstance. The Beer-Lambert's law is a deterministic methodology, and it is the least complex model connected to assess the optical misfortune [4].

By its numerical definition, it accepts that the got light power diminishes exponentially as a function of the spread separation, constriction coefficient, characterized as the aggregate of absorption and scattering coefficients, and source force. In any case, this methodology ignores the way that the dissipated photons can even now be caught at the recipient, and hence it thinks little of the got power [12]. Then again, Monte Carlo strategy is the most mainstream numerical way to deal with assess the optical way misfortune in underwater medium. It is a probabilistic strategy that imitates the loss of underwater light proliferation by transmitting and directing the spread conduct of an extensive number of photons [13]. The fundamental preferred standpoint of that technique is its effortlessness to actualize in programming stages, and notwithstanding giving an answer adequate precision frequently. In any case, its principle downside lies in the arbitrary factual blunders and its long running time too.

II.EXISTING SYSTEM:

It comprises on transmitting the data motions as light tapered shafts utilizing LED or Laser gadgets through the free space. By and large, two marvels degenerate the light spread in the underwater conditions, in particular light absorption and scattering, which are the two noteworthy Inherent Optical Properties (IOPs) that decides light power misfortune . So as to break down and foresee the all out light power misfortune in the underwater medium, a few methodologies have been associated with this context.It comprises on transmitting the data motions as light cone shaped pillars utilizing LED or Laser gadgets through the free space. All in all, two marvels degenerate the light proliferation in the underwater conditions, specifically light absorption and scattering, which are the two noteworthy Inherent Optical Properties (IOPs) that decides light power misfortune . So as to investigate and foresee the all out light power misfortune in the underwater medium, a few methodologies have been associated with this context.The Beer-Lambert's law is a deterministic methodology, and it is the easiest model connected to assess the optical loss.However, this methodology ignores the way that the dissipated photons can in any case be caught at the collector, and along these lines it disparages the got influence. Then again, Monte Carlo technique is the most prominent numerical way to deal with assess the optical way misfortune in underwater medium. It is a probabilistic strategy that imitates the loss of underwater light spread by transmitting and managing the engendering conduct of countless.

Disadvantages of Existing system:

- 1.) Not accurate.
- 2.)Highly complex.
- 3.) Efficiency is very less.
- 4.) Path loss estimation and control Capability is less
- 5.)Requires huge hardware.
- 6.) High processing time.
- 7.) Existing Approaches cannot path loss efficiently.
- 8.)Consumes huge power .
- 9.) High Operational and maintenance cost.

III.PROPOSED SYSTEM:

In this system, we proposed another improved numerical way to deal with assess the time-subordinate Radiative Transfer Equation (RTE) for underwater optical wireless communication (UOWC) systems. We include the time-subordinate term in the RTE. The de-ri-ved arrangement relies upon both time and the engendering separation. Not at all like the finite contrast plot proposed in [1] where just a single neighbor point has been utilized, we utilize a progressively exact finite upwind distinction conspire including tw neighbor focuses, while we utilize the upwind Euler difference formula for the time derivative.

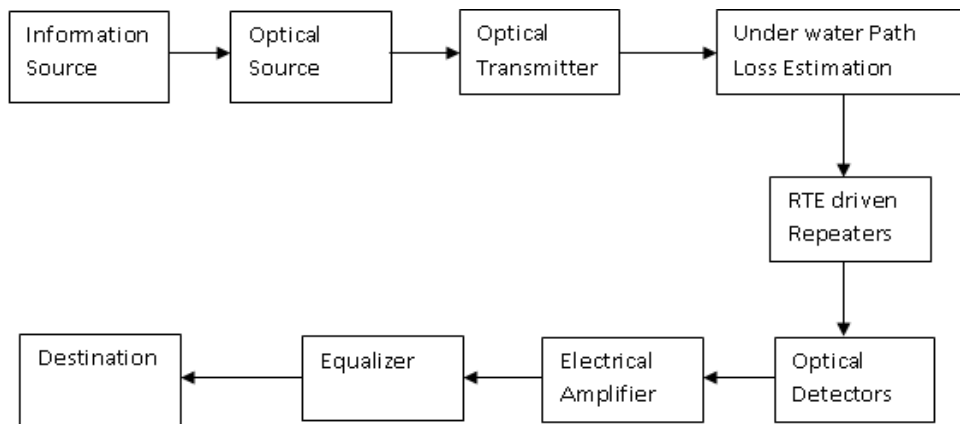

Fig(1):Schematic Block Overview of the proposed system.

We change the 3 Simpson's quadrature strategy utilized, by including the 5-points Boole's standard given by the Newton-Cotes equation. The completely discretized arrangement of equations is iteratively understood as a function of the discretized time ventures until achieving the convergence. We register the absolute got control in the collector plane as a function of the spread separation and time as well. The UOWC framework's bit mistake rate (BER) execution metric has been assessed versus time and separation.

$$\left[\frac{1}{v} \frac{\partial}{\partial t} + \vec{n} \cdot \nabla \right] L(t, \vec{r}, \vec{n}) = -cL(t, \vec{r}, \vec{n}) + b \int \int_{\Omega=4\pi} \beta(\vec{n}, \vec{n}') L(t, \vec{r}, \vec{n}') d\vec{n}' + S(t),$$

The prompt light brilliance is the arrangement of the three dimensional time-subordinate RTE as pursues

Considering a two-dimensional engendering situation, where the precise headings of light spread range in the interim $[0, 2\pi]$, the rakish space is discretized into Kdirections unequally divided ϕ_k that limits the accompanying mean squared mistake .

We note that the rakish discretization is symmetric as for the reference forward heading ($\phi_1 = 0$) . To tackle numerically the basic of the correct hand side of the RTE equation (1), we utilize the Simpson's technique joined with the 5 Boole's standard given by the Newton-Cotes formula. In our examination, the recipient is set on the XOY plane. Knowing that the determined brilliance is performed in the YOZ plane, the got power is determined by summing up the light brilliance at matrix focuses in the collector plane opposite to the z-axis (i.e., XOY plane). Utilizing a similar key that was utilized in encryption the encoded picture is dissected at various scales and levels to distinguish the concealed double information streams in the image. All the recognized shrouded paired information streams are upgraded and assembled in a fitting design to get the generally shrouded information with no losses. After extricated all twofold shrouded information vectors, every one of these information vectors are decoded consolidated and summed together to get the first concealed information.

Advantages of proposed system:

- 1.) Highly accurate.
- 2.) Computational complexity is very less.
- 3.) Efficiency is very high.
- 4.) Path loss estimation and control Capability is high

- 5.) Requires less hardware.
- 6.) Low processing time.
- 7.) Proposed Approach can calculate path loss efficiently.
- 8.) Consumes low power .
- 9.) Low Operational and maintenance cost.

VI.RESULTS:

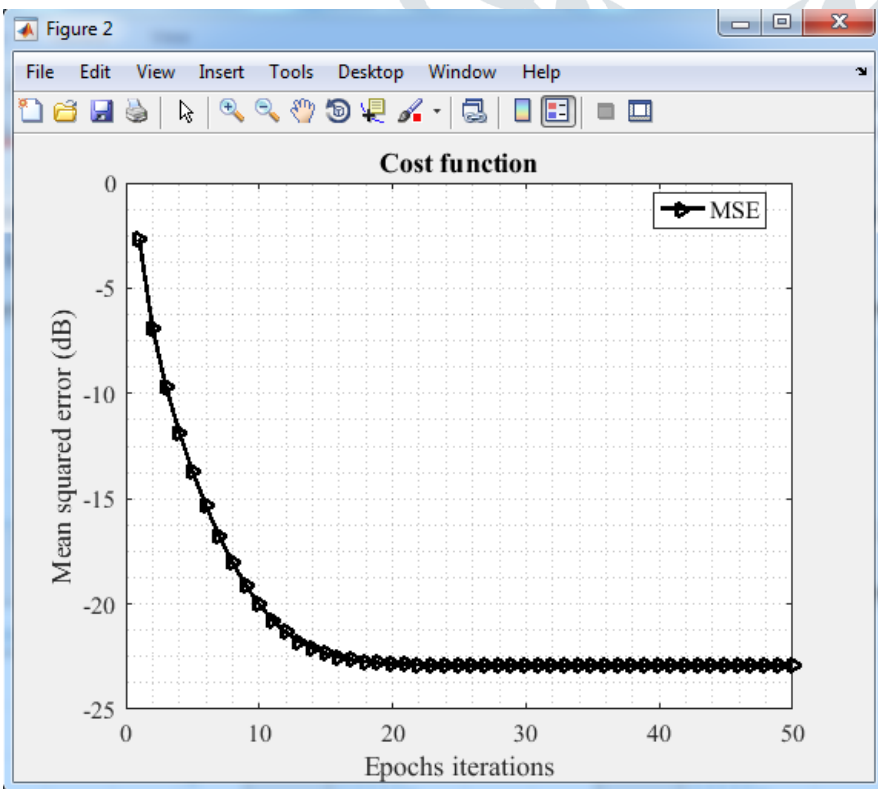
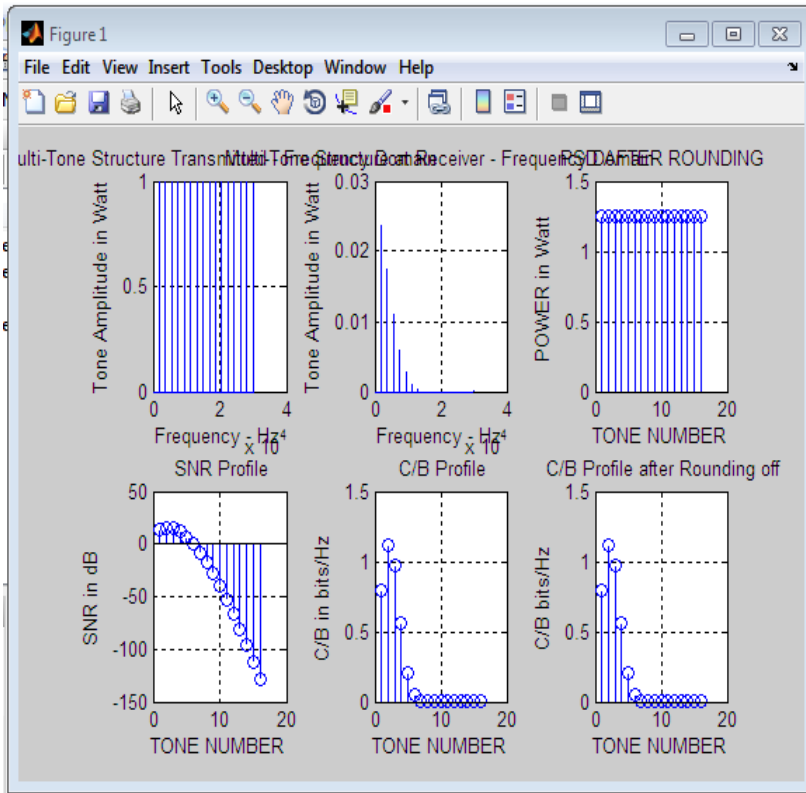

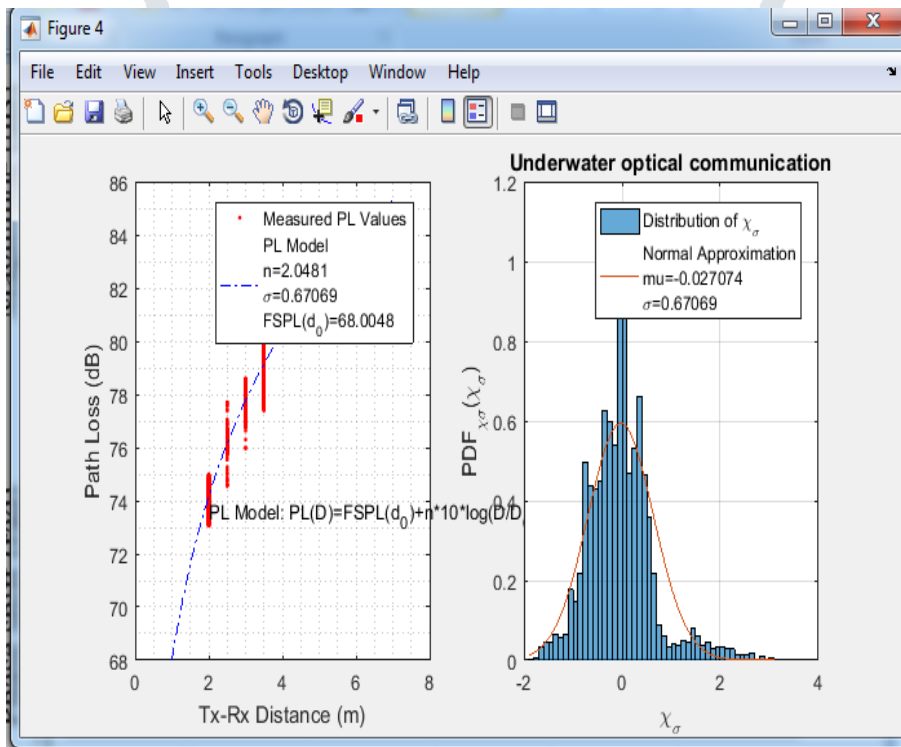
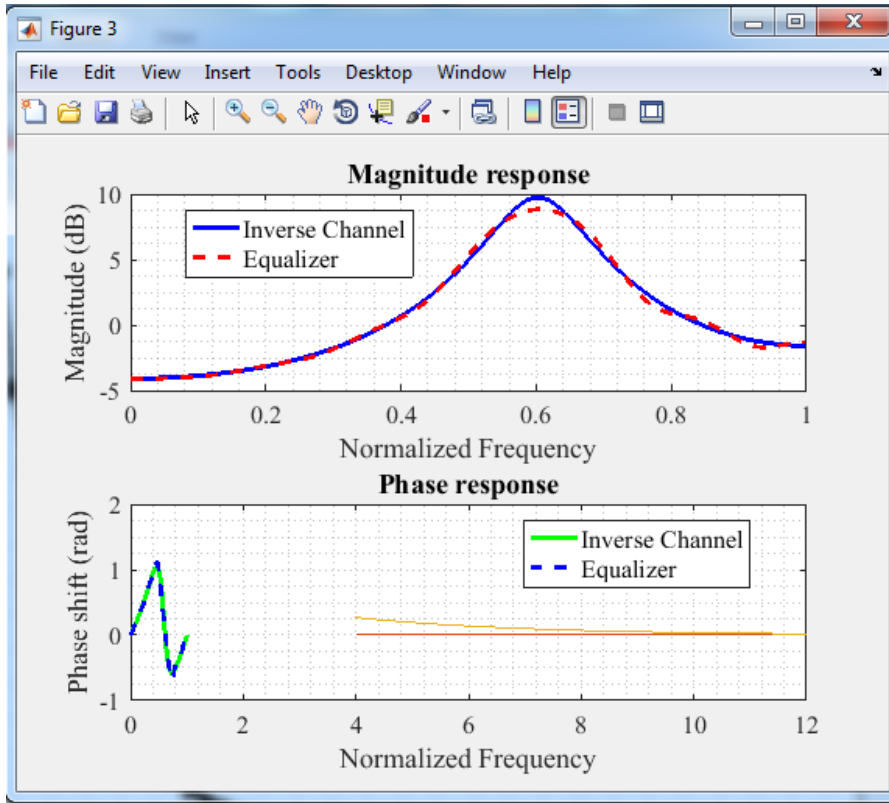

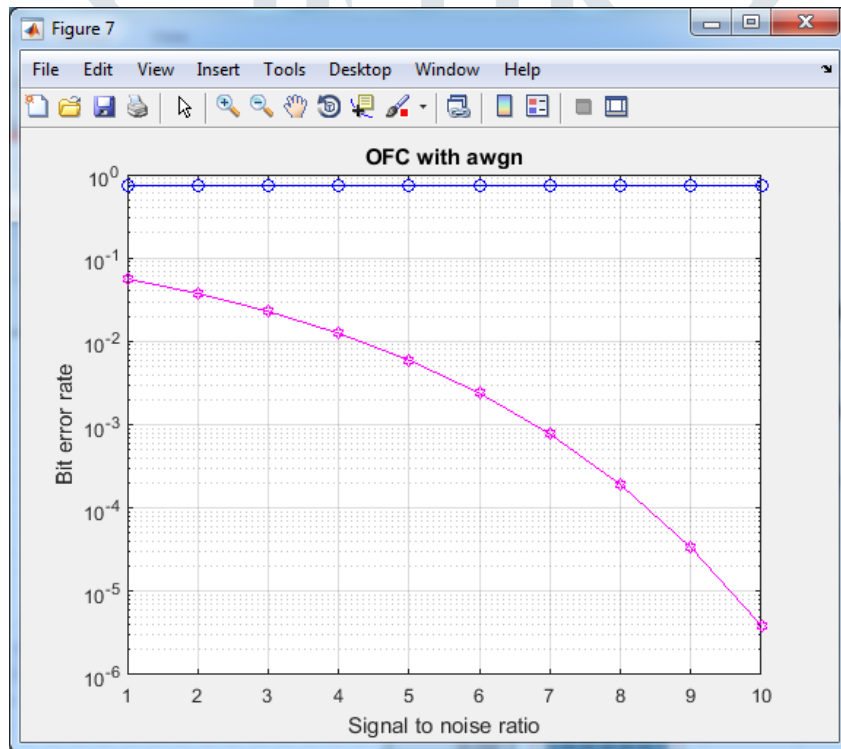
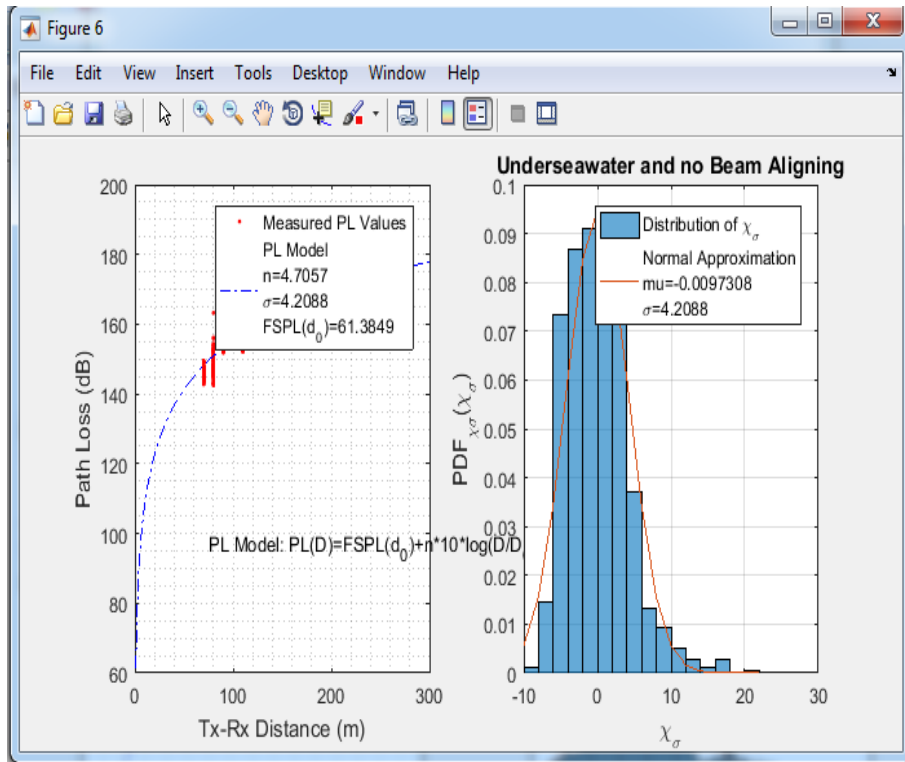

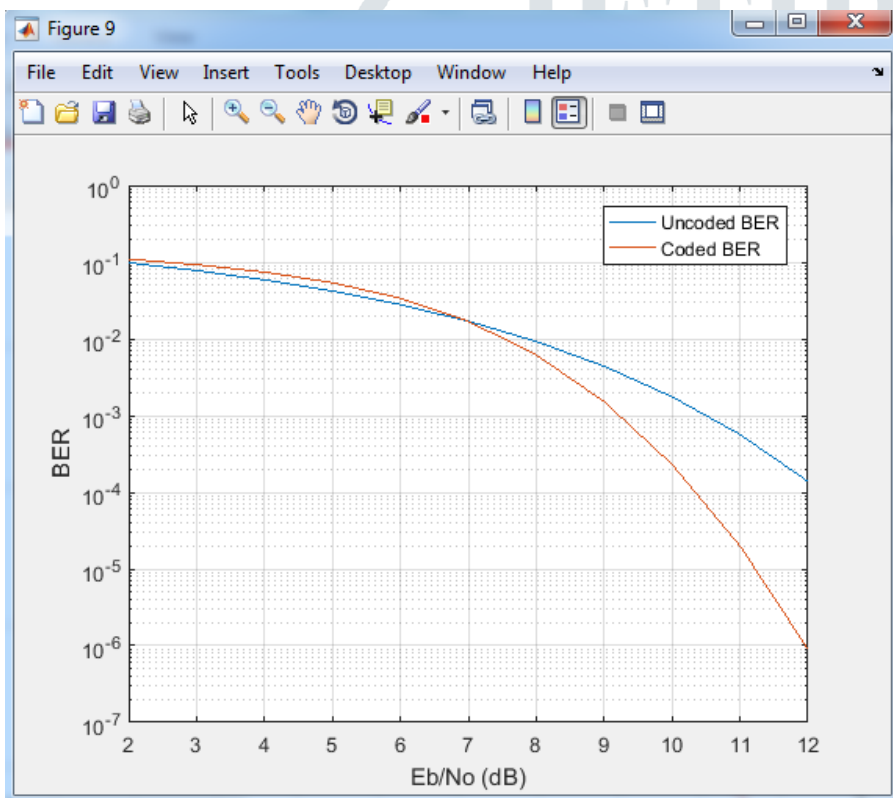
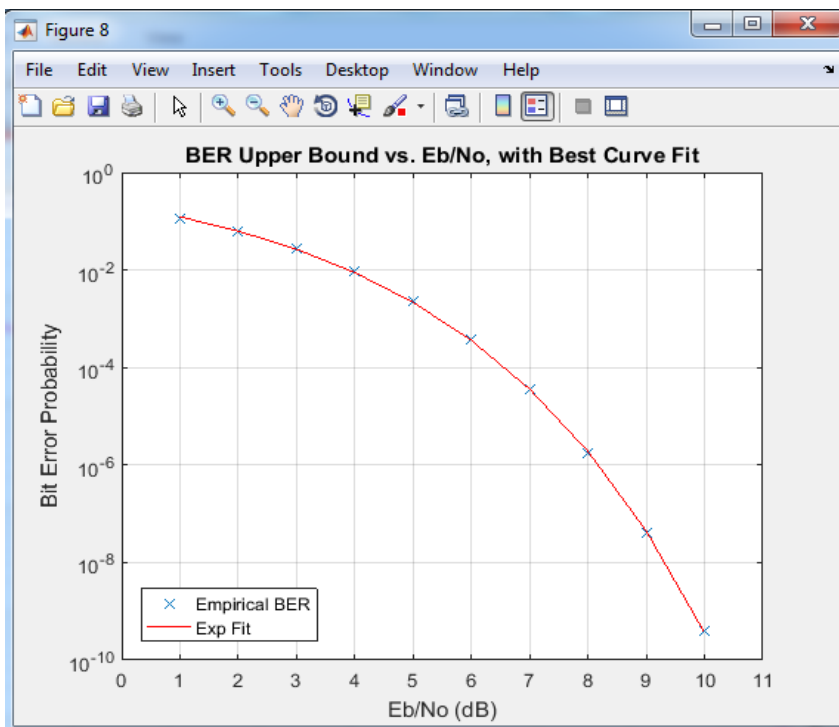

V.CONCLUSION:

In this paper, we proposed effectively an improved RTE control calculation so as to fathom the time-dependent radiative transfer equation, which completely portrays the light proliferation conduct on underwater medium. We utilized the Boole's standard given by the 5-points Newton-Cotes equation as a quadrature technique close by with the two and three Simpson's strategy so as to illuminate the necessary term. The upwind limited contrast conspire was likewise improved by including one more neighbor point. We determined the got light brilliance as a function of the proliferation separation and time, at that point we assessed the got light power by summing up the determined brilliance at the recipient plane. Bit mistake rate execution metric was assessed excessively dependent on the registered got control with the nearness of clamor hindrances, as a function of spread separation, time, and beneficiary parameters, for example, load obstruction, photodetector responsivity, and electrical channel bandwidth.

REFERENCES:

- [1] A. Klose and A. H. Hielscher, "Iterative reconstruction scheme for optical tomography based on the equation of radiative transfer", *Medical Physics*, vol. 26, no. 8, pp. 1698-1707, August 1999.
- [2] H. Gao and H. Zhao, "A Fast-Forward Solver of Radiative Transfer Equation", *Transport Theory and Statistical Physics*, vol. 38, no. 3, pp. 149-192, September 2009.
- [3] L. Johnson, R. Green, and Mark Leeson, "A Survey of Channel Models for Underwater Optical Wireless Communication," in the IEEE 2013 2nd International Workshop on Optical Wireless Communication (IWOW) proceedings, Newcastle upon Tyne, UK, 21-21 Oct. 2013.
- [4] Z. Zeng, S. Fu, H. Zhang, Y. Dong, and J. Cheng, "A Survey of Underwater Wireless Optical Communication," *IEEE Communications Surveys and Tutorials*, vol. 19, no. 1, pp. 204 - 238, October 2016.
- [5] S. Arnon, J. R. Barry, G. K. Karagiannidis, R. Schober, and M. Uysal, *Advanced Optical Wireless Communication Systems*. Cambridge: Cambridge University press, 2012.
- [6] E. M. Sozer, M. Stojanovic, and J. G. Proakis, "Underwater Acoustic Networks", *IEEE Journal of Oceanic Engineering*, vol. 25, no. 1, pp. 72-83, January 2000
- [7] S. Arnon, "Underwater optical wireless communication network," *Optical Engineering*, vol. 49, no. 1, January 2010.
- [8] E. Illi, F. El Bouanani, and F. Ayoub, "Asymptotic Analysis of Underwater Communication System subject to κ - μ Shadowed Fading Channel," in 2017 13th International Wireless Communications and Mobile Computing Conference (IWCMC) proceedings, Valencia, Spain, 26-30 June 2017.
- [9] Z. Ghassemlooy, W. Popoola, and S. Rajbhandari, *Optical Wireless Communications: System and Channel Modelling with MATLAB*. Boca Raton: CRC Press, 2013.
- [10] M.-A. Khalighi, C. Gabriel, T. Hamza, S. Bourennane, P. Leon, and V. Rigaud, "Underwater wireless optical communication: Recent advances and remaining challenges," in Proc. International Conference on Transparent Optical Networks (ICTON), Center Graz (Grazer Messe), Austria, pp. 1-4, 6-10 July 2014.
- [11] C. Mobley, E. Boss, and C. Roesler, "Ocean optics web book," 2010. [Online]. Available: <http://www.oceanopticsbook.info/>
- [12] C. Li, K.-H. Park, and M.-S. Alouini, "On the Use of a Direct Radiative Transfer Equation Solver for Path Loss Calculation in Underwater Optical Wireless Channels", *IEEE Wireless Communications Letters*, vol. 4, no. 5, pp. 561 - 564, October 2015.
- [13] W. C. Cox, Jr., "Simulation, Modeling, and Design of Underwater Optical Communication Systems". Raleigh, NC, USA: North Carolina State Univ., 2012. [Online]. Available: <http://www.github.com/gallamine/photonator>
- [14] H. Kaushal and G. Kaddoum, "Underwater Optical Wireless Communication," *IEEE Access*, vol.4, pp. 1518-1547, April 2016.
- [15] S. Lloyd, "Least squares quantization in PCM," *IEEE Trans. Inf. Theory*, vol. 28, no. 2, pp. 129-137, Mar. 1982.