



SMART ANNOUNCEMENT AND IVRS SYSTEM FOR PUBLIC TRANSPORTATION

¹Prof. S. T. Matale, ²Sonali M. Mangavkar, ³Ankita A. Chougule, ⁴Maheshwari V. Lohar

¹Assistant Professor, ²Engineering Student, ³Engineering Student, ⁴Engineering Student

¹Department Of Electronics And Telecommunication Engineering Mahagaon,

¹Sant Gajanan Maharaj College Of Engineering , Mahagaon, India

Abstract : The smart announcement and IVRS system is a bus detection and announcement system that uses RFID technology to make travelling and movement easier for blind people. In today's bus transportation system, each bus requires human intervention to report the bus number, arrival time, and departure time. This process takes at least 4-5 minutes for each stop, resulting in unnecessary time waste. Furthermore, passengers are frequently unable to obtain accurate information about bus arrivals and departures. To address this issue, we propose an RFID-based IVRS system. The developed system completely eliminates manual reporting, which may save passengers 15-20 minutes, which may increase depending on the number of stops in the journey. There were issues with the timing of the bus's arrival or departure also minimized. Furthermore, the system eliminates human intervention, which eliminates the possibility of errors occurring during reporting and announcement. In addition to these results, spending on dedicated staff only for announcements can be reduced. This project also offers ticketing and seat reservations.

IndexTerms - RFID, IVRS SYSTEM, ANNOUNCEMENT, VOICE MODULE.

1. INTRODUCTION

We propose an RFID-based system for bus identification at bus stops. Once the bus arrives at the bus station, it is detected by the RFID tag at the bus terminal, and an automated speech enabled system announces the arrival and departure times, as well as bus detail information. The work's novelty is based on automated bus announcements, which are currently carried out with human intervention. The platform chosen for this type of system is RF Technology, which has grown in popularity and is now owned by nearly every second person for wireless communication purposes. It facilitates access for all users because no manual interaction is required. The work requires an automated announcement to the server when the bus arrives at its depot. This benefits both the conductor/driver and the passenger by saving time. Furthermore, after observing the problems that ordinary people face, we concluded that there should be a need for or a solution that can reduce their effort while travelling on a daily basis. Also, because no manual interaction is required with the system, illiterate people can easily use it. As a result, the burden of keeping records for each and every bus arriving at the depot is reduced. The majority of public transportation is provided by buses. Increased use of buses will automatically result in decreased use of private transportation, reducing road traffic congestion. Bus services also contribute to lower fuel consumption. Buses are the most common mode of transportation. We conducted a survey at various bus terminals. We discovered that each depot requires human intervention for announcements of buses after they arrive, which takes the majority of the time. So we attempted to create a system that is also comfortable for all passengers while saving a significant amount of time on announcements at each depot.

2. Literature Survey

1. This paper describes [1] a bus detection system for blind people that makes use of RFID. The proposed system is simple and convenient for all passengers, not just those who are blind. So, with an estimated 40 to 45 million blind people worldwide, special services should be provided to give them the right to live as others do.
2. From [2] A feasible system for assisting blind people in safe and normal public transportation travel has been proposed, and the prototype has been tested for various sample RFID tags. The system's performance is satisfactory, and it promises to eliminate the difficulties that blind people face when using public transportation on a daily basis.
3. The system's two subsystems are the bus subsystem and the station subsystem[3]. The bus subsystem notifies all passengers of the next stops on the bus route. Furthermore, the number of blind people who need the bus as well as their destinations will be communicated to the bus driver. The announcement will be made by the station's subsystem.

4. We observed the operation of the Bus reservation system [4], and after going through it, we discovered that there are many operations that they must perform manually. It takes a long time and causes numerous errors when entering data. As a result, they encountered numerous problems and had numerous customer disputes.
5. Using this new system, all information about the customer making a reservation can be obtained by clicking a button, eliminating some of the difficulties associated with the manual system. This will reduce employee workload, reduce the time required to make reservations at the bus terminal, and increase efficiency.

3. BLOCK DIAGRAM

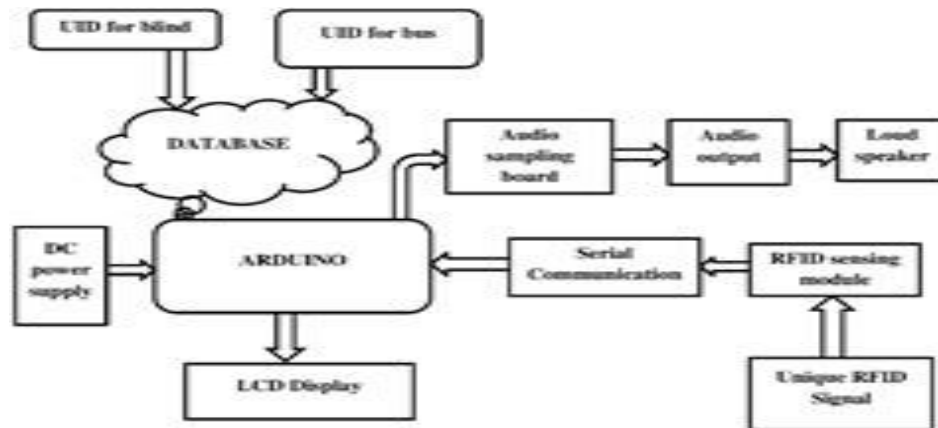

fig 3. block diagram of IVRS system

4. CIRCUIT DIAGRAM

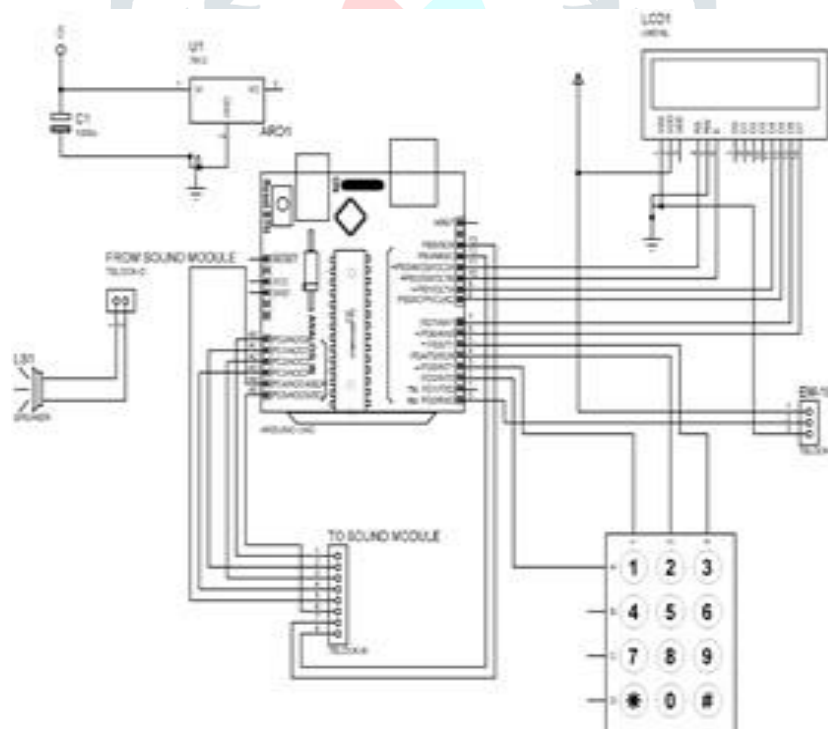

fig 4. circuit diagram of IVRS system

5. FLOWCHART OF IVRS SYSTEM

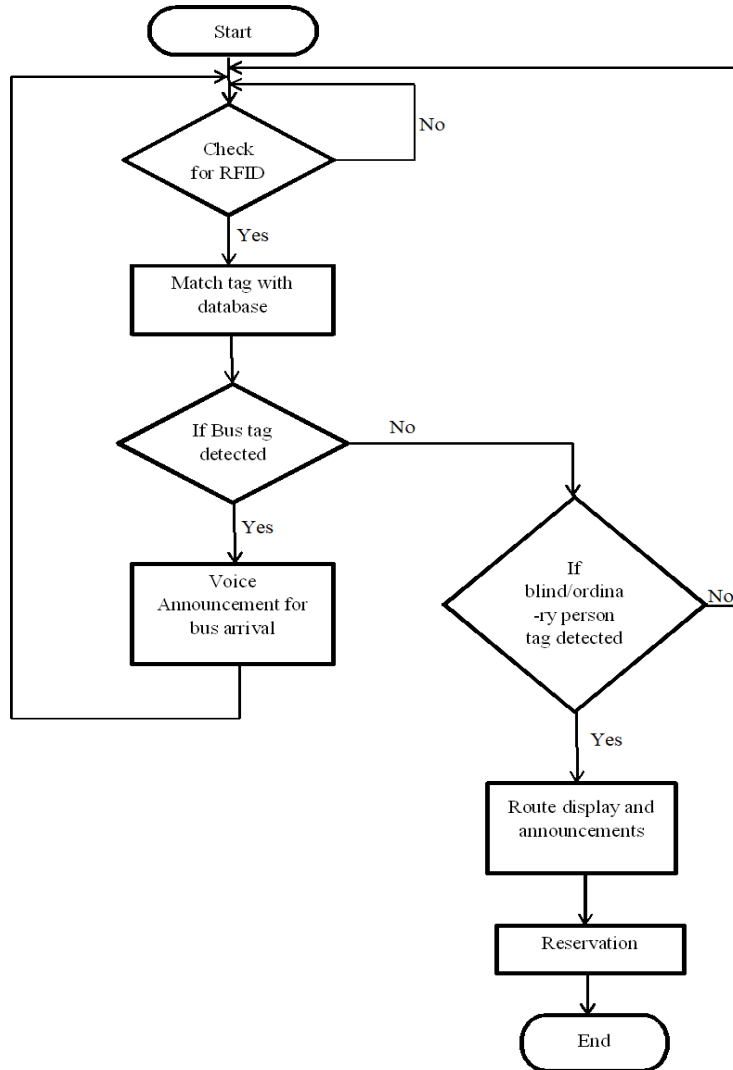

fig. 5 flowchart

6. WORKING OF IVRS SYSTEM



fig.6 screenshot of IVRS system

There are several steps in Designing of IVRS system :

- analyzing the problem in existing system .
- market survey of material availability and costing.
- selection of material to make a module
- designing basic structure of the project .
- assembling every module.
- designing final circuit.
- coding and testing.
- Final result .

7. PROPOSED WORK

1) SOFTWARE PART:

A typical IVRS system is made up of two processing components:

- (a) Subsystem of a bus station
- (b) Ticketing System

A. BUS STATION SUBSYSTEM:

The bus subsystem will include a central announcement system to inform all passengers in the bus terminal about routes, as well as blind people. This will satisfy our requirement that the System benefit passengers other than blind people. A detection subsystem (RFID Reader), an announcement system, and an RFID tag comprise the bus station subsystem. Each blind person in our system will be given an RFID tag that is linked to information about the required bus number and destinations via the system database. When the blind person receives the tag, this information is entered into the database.

The flowchart of the IVRS system is shown in Figure, which begins by checking for bus arrival. The control subsystem will retrieve the bus number and route from the database if the bus ID tag is read. The station control subsystem will then announce bus routes, arrival and departure times, and bus detail information. The system responds to each case differently depending on the RFID tag detected (if any):

- Blind person tag is detected:

The system can determine whether or not the blind person needs the bus based on the information stored in the system database about the tag. If yes, then after the tag is detected, the bus routes for that blind person are announced, as well as the routes and their charges, which are displayed on the LCD display.

- Station tag is detected:

After the station tag is detected, an automated speech enabled system will generate a voice announcement when the bus arrives at the bus terminal.

For coding, we use the Arduino IDE software, and for PCB design, we use the proteus software.

B. Ticketing subsystem:

We are also proposing an automated ticket enabled system at the bus terminal in the ticketing subsystem. When a tag is detected, the dedicated routes and their associated charges are announced via the IVRS system and displayed on the LCD display. With this new system, all information about passengers making a reservation can be obtained by clicking a button, eliminating some of the difficulties associated with the manual system. This reduces the workload of the dedicated staff while also increasing efficiency.

2) HARDWARE PART:

1. RFID tag:

The image below depicts an RFID tag (smart card shaped tag). RFID tags are available in various shapes and sizes. The Tag includes an IC for storing data, an antenna for transmitting and receiving data, and a modulator. Tags are small and can only hold a few bits of data. The operation of a reader is very similar to that of a barcode scanning method that employs Universal Product Codes (UPC) codes. RFID Tag and Reader have advantages over barcode systems in some applications.

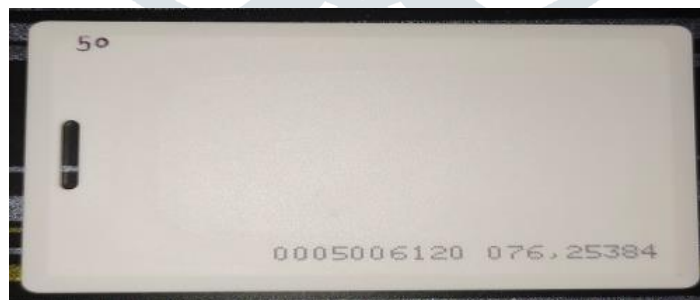

fig 7.2.1. RFID tag

2. RFID reader :

Within the RFID reader is a radio transmitter and receiver. When powered on, the reader continuously transmits radio frequency signals. It is also referred to as an interrogator. When an RFID tag is placed within a reader's range, the reader energises the tag via electromagnetic induction and collects data from it. The RFID tag electronically stores data. Tags can only store a few kilobytes of data. The reader retrieves this data using electromagnetic waves.

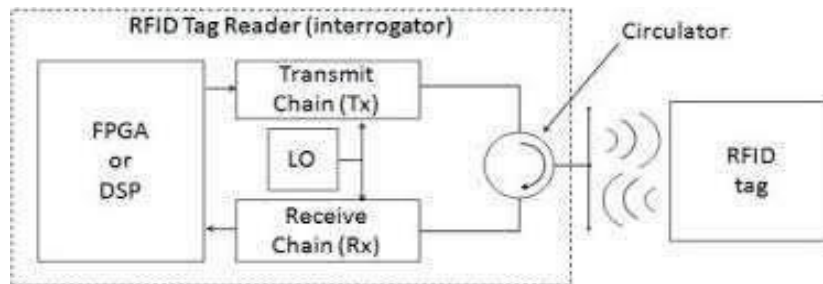

fig 7.2. 2.A. working of RFID

These tags are commonly used in applications such as race timing, file tracking, and so on. RFID tags can be used at three different frequencies.

They are:

1. Low frequency (125-134 kHz): At this frequency level, range of the reader up to which it can read from the tag is very short distance. It is about the 1-10 centimeters.
2. High Frequency (13.56 MHz): The range of RFID at this frequency level is 10 centimeter to 1 meter. This frequency can be used in applications where short range is sufficient such as passport. Larger UHF tags can read up to 30+ meters. Such UHF tags can be used in applications such as IT assets tracking, file tracking etc.
3. Very high Frequency (865-960MHz): The range of reader at the frequency is about 5 to 6 meters.

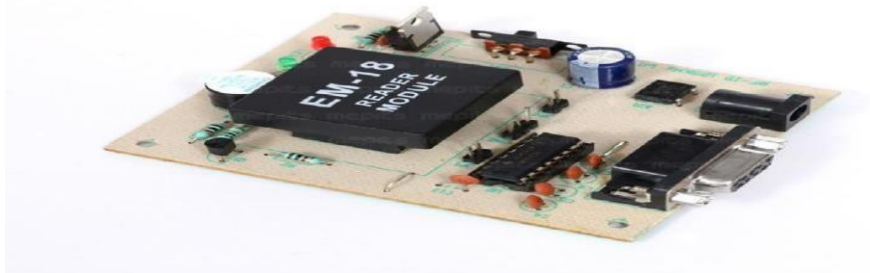

fig 7.2.B. EM18 RFID module

3. Arduino Uno:

The Arduino Uno microcontroller board is an open-source electronics platform based primarily on the AVR microcontroller. It has 14 digital input/output pins, 6 analogue inputs, a 16 MHz quartz crystal, a USB connection, an ICSP Header, a reset button, and a power jack, allowing designers to control and sense external electronic devices in their world.

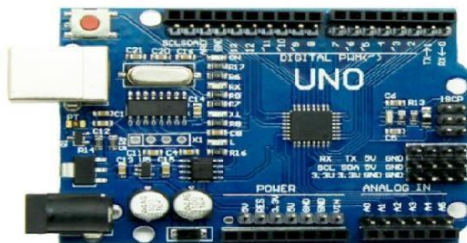

fig 7.2.3 arduino uno

4. LCD:

We use a 24*7 LCD display with 16 pins in this application. A 20x4 LCD can display 20 characters per line and has four suchlines. Each character is displayed in a 5x7 pixel matrix on this LCD. This LCD contains two registers: Commn and Data

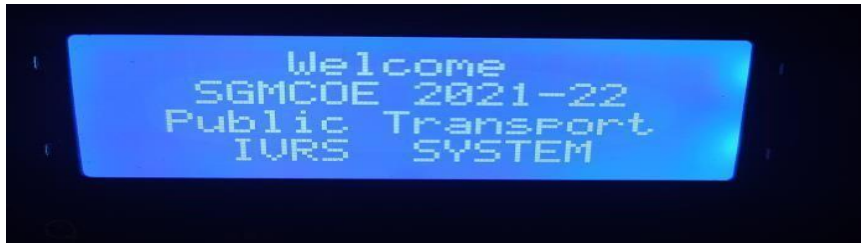

fig.7.2.4 LCD

5. APR33A3 MODULE:

The APR33A series includes a powerful audio processor as well as high-performance audio digital to analogue and analogue to digital converters. It is specially designed for simple key trigger, and the user can record and play back the message for one, two, four, or eight voice messages by switching. We have recorded the following messages in this voice IC for announcement on the bus terminal:

1. Welcome to gadhinglaj. the bus arrived at plot 1.
2. the bus route is 1. Nipani , 2. Kagal, 3. Kolhapur
3. the bus route is 1. Ainapur , 2. Khoratwadi, 3. Ajara
4. Welcome User. select your stop to confirm the ticket
5. booking successful. Your seat no. is 1
6. booking successful. Your seat no. is 2
7. Sorry, Your balance is insufficient.
8. Sorry, No seats available.

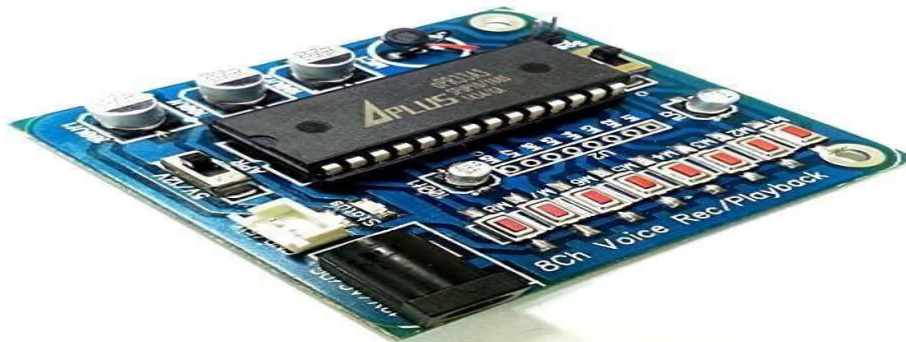

fig 7.2.5. APR33A3 module

6. Keypad:

fig 7.2.6. keypad

7. Speaker:

In this project we use 4 ohm, 6 watt speaker for announcements on bus terminal. A 4x4 keypad has a total of eight connections, four of which are connected to the matrix of switches' column and the remaining rows. When a single button is pressed, a link is formed between one of the rows and columns.

8. RESULT

8.1 BUS ARRIVED AT BUS STATION

Once the bus arrives at the bus station, it is detected by the RFID tag at the bus terminal, and an automated speech enabled system announces information about the bus routes and their respective charges on the LCD display.



fig.8.1 bus arrived at station

8.2 TAG DETECTION

When a user tag is detected, the IVRS system announces the dedicated routes and their associated charges and displays them on the LCD display. Reservations can be obtained using this new system by simply clicking a button.

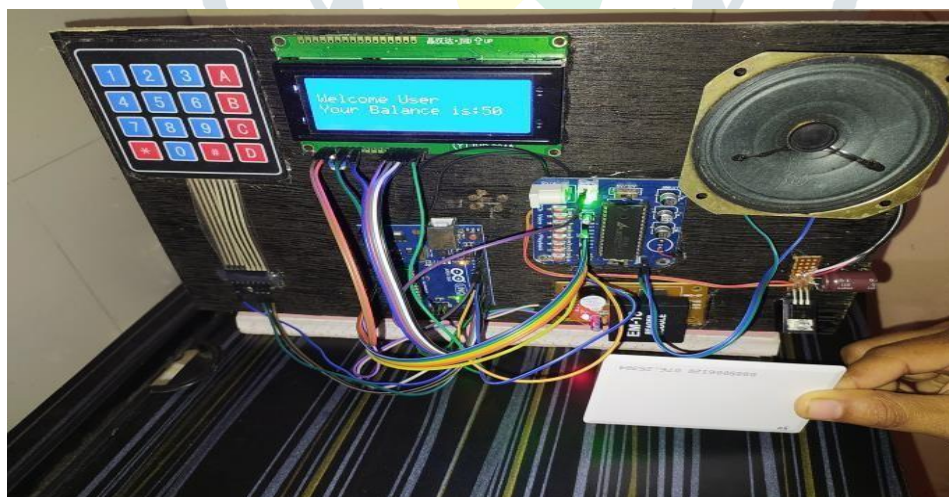

fig 8.2 for tag detection

8.3 SEAT RESERVATION

This system allows you to make a reservation by simply clicking a button. If the seats are available, it announces and displays a booking successful message with the reserved seat number, as well as the user balance. If no seats are available, the system will display the message "No seats available."



fig 8.3. A seat reservation for seat 1



fig 8.3. B seat reservation for seat 2

8.4 DISPLAY LOW BALANCE

When the user tag is detected and the user balance is insufficient to confirm the ticket, the system will announce 'Your balance is insufficient' and display the insufficient balance message.



fig.8.4 for display low balance

9. CONCLUSION

There are between 40 and 45 million visually impaired people worldwide. Some special services should be provided to them in order to grant them the right to live as others do. We presented a bus detection and announcement system for visually impaired people using RFID technology in this paper. We offer a convenient service for both visually impaired and non-visuallyimpaired people. In addition, we provide a ticketing system in this project, which will reduce the workload of the dedicated staff while also increasing efficiency. This system is extremely efficient and allows visually impaired people to board buses without assistance. Notifying the visually impaired person of the arrival and status of the bus.

10. REFERENCES

1. On The Bus Public Transport. Available at: <http://www.onthebus-project.com>, Accessed 25 Novmber 2015.
2. IEEE Standard C95.1 (2005), IEEE Standard for Safety Levels with Respect to Human Exposure to Radio Frequency Electromagnetic Fields 3 kHz to 300 GHz, Available from: <http://standards.ieee.org/findstds/standard/C95.1-2005.html>, Accessed 25 (2015).
3. New York Transportation Statistics. Available from: <http://transportation-modes-city.findthedata.org/q/1447/1033/How-many-people-use-publictransportation-to-commute-in-New-York-New-York>. Accessed 25 November 2015.
4. <https://www.lovelycoding.org/bus-reservation-system/>
5. University Press- Wee K. L. (2007): Bus Reservation System: Faculty of Information and Communications Technology,Universiti teknikal Malaysia Melaka Winston O.F. (1995): Information Management and Computer Processing. Journal of Information Technology, Massachusetts, Vol.2, pag 35-43, Wikipedia, (2014): http://en.wikipedia.org/wiki/Web_application.
6. <http://standards.ieee.org/findstds/standard/C95.1-2005.html>. Accessed 25 November 2015.
7. J. Al Kalbani, R. B. Suwailam, A. Al Yafai, D. Al Abri and M. Awadalla, Bus Detection System for Blind People using RFID, Proceedings of the 8th IEEE GCC Conference and Exhibition, Muscat, Oman (2015).

