



Dynamic And Impact Analysis On Battery Pack For An E-BIKE

¹Chandrashekar Hiregoudar, ²S Sofi Sarmas hussaini

¹ Associate Professor, ² P G Student,

¹⁻²Department of Mechanical Engineering, RYM Engineering College, Ballari, Karnataka, India

Abstract: Global warming has been a problem for the world during the last few decades. Burning fossil fuels to produce energy may accelerate technological advancement, but it also causes resources to degrade and the atmosphere to fill with greenhouse gases. Due to its efficiency, environmental friendliness, and quiet operation, EV use is unavoidable. Battery storage systems (BSSs) are into since they are the primary power source for EVs. The EV sector generally prefers Li-ion batteries within this context.

The two main obstacles to widespread electrification of the transportation industry for vehicles on roads are safety and dependability. Due to factors like constant mechanical vibration transmission, exposure to strong impact pressures, and thermal runaway, current Li-ion battery packs are vulnerable to failure [2]. Due to their extreme sensitivity to ambient temperature, pressure, and dynamic mechanical loads, lithium-ion (Li-ion) battery packs in electric vehicles (EV) are susceptible to failure in these situations [3]. There will be varying degrees of strains and deformations as a result. The safety of the battery pack, in turn, depends on the mechanical characteristics of the battery pack, such as its resistance to deformation and vibration shocks. The vehicle safety heavily depends on the safety of battery pack which in turn is dependent on its mechanical features, such as the ability to resist deformation and vibration shocks. In this study, a design optimization methodology is proposed to optimize the features of mechanical design (e.g., minimization of mass, maximization of minimum natural frequency and minimization of maximum deformation) of the battery pack enclosure.

Index Terms –EV- Electric vehicle, BEV-Battery electric vehicle, BP-Battery pack, internal combustion engine (ICE) hybrid electric vehicles (HEVs), lithium-ion (Li-ion)

I. INTRODUCTION

1.1 OVERVIEW OF DEVELOPMENT OF BATTERY ELECTRIC VEHICLE

1.1.1 MARKET MOTIVATION FOR EV

One of the major challenges in the global society today is to reduce the negative impacts that road transportation has on the environment due to toxic and green-house-gas emissions. As a consequence, these type of emissions from vehicles are legally regulated on national and sometimes regional levels. In order to comply with expected near future more stringent regulations, vehicle manufacturers are forced to invest in various fuel saving technologies. This has led to an increased interest in vehicle electrification, foremost hybrid electric vehicles (HEVs) which can reduce fuel consumption compared to conventional vehicles, but also battery electric vehicles (BEVs). BEVs offer high power train efficiency and no tailpipe emissions, which is why they are so far considered CO₂ neutral in the regulations. If charged with electricity that is produced by fossil free and renewable sources, BEVs have the potential to offer an emission free use phase. Today a large part of the major automotive manufacturers in the world have developed their own BEV model, and BEV sales have seen increased annual growth rates, as high as 54%-87% during 2012-2014. Still, the battery related drawbacks of relatively short driving range (mainly due to prize constraints) combined with long charging time, prohibit BEVs from taking up the commercial competition with fuel energized cars on a large scale just yet.

1.1.2 GLOBAL SCENARIO

Paris agreement has united 195 countries of the world who share a common goal of limiting the greenhouse gas emissions and gradually building a carbon-free society. Significant efforts are thus being focussed on increasing the share of renewable energy in the total energy generated in these regions. However, the problem of intermittency affects all renewable energy resources. Use of battery packs to add an energy buffer and increase flexibility of the electric grids is considered a reliable as well as a sustainable solution for the problem of intermittency associated with renewable energy sources. Also, battery-powered vehicles have the potential to substantially cut the greenhouse gas emissions from the transport sector. Electrification of transportation sector is thus integral to the long-term climate control policies of all nations.

Among the commercially available battery chemistries, Li-ion batteries offer features such as high efficiency, high gravimetric and volumetric densities, longer lifespan and low maintenance requirements that are all essential for setting up an efficient energy storage system. Currently, the cost of manufacturing an EV battery pack is about \$500 per kWh. However, with efforts to modify the microstructure of electrode materials for Li-ion batteries, the cost is expected to decrease to \$200 per kWh by 2020 and \$160 by 2025. Lastly, Li-ion batteries containing non-toxic metals such as iron, nickel, manganese, cobalt, have been classified as “non-hazardous waste and safe for disposal in the normal municipal waste stream” by the US government. For these reasons, they are the preferred choice for the majority of high energy or high-power applications in present times.

1.1.3 SOCIAL RELEVANCE

More than 70% of the original equipment manufacturers (OEMs) are investing in vehicle technologies that will connect to the electricity grid and employ electrical energy as their motive power.

Currently, electric vehicles (EVs) account for only 0.1% of the global light-duty vehicle stock, and large-scale electrification of the road transportation sector seems challenging. The primary issue is the comparatively high retail cost of EVs, which are currently twice as expensive as their internal combustion engine (ICE) equivalents. An EV battery pack accounts for up to 46% of this cost. Hence, possible cost reduction techniques, such as modification of the microstructure of existing electrode materials for lithium-ion (Li-ion) battery cells and the development of new battery chemistries are being pursued extensively by different research groups. These efforts have been partially successful, it is therefore assumed that battery packs will continue to be the controlling factor in the costing of electric drive train architecture for next 5 to 7 years. As time-to-market is becoming increasingly important for the success of any new product, it is vital to investigate other means of facilitating the design and manufacturing of battery packs that can provide immediate economic benefits to EV users.

1.1.4 PROSPECTIVE SOLUTION

Over the last few decades and across several sectors, including the automotive sector, modularity has emerged as a means to improve the economics of an industry. A modular design would allow OEMs to scale up a battery pack and meet the energy/power requirements of different EV applications, without necessitating major structural modifications to the basic pack architecture. This would enable mass production of battery cells, which in turn would reduce manufacturing costs for EV battery packs. In addition, it would enable OEMs to accommodate future uncertainties. For example, if a new battery chemistry with higher energy or power density becomes commercially accessible, modularity-in-design will allow EV battery packs to evolve with the new technology easily and at low cost.

1.1.4 PROBLEM AREA

To sum up, increased usage of lithium-ion batteries in automotive applications makes it necessary to understand their mechanical behavior under extreme loading conditions, such as mechanical impact. One of the key design aspects of any energy storage system, including batteries, is safety, which can be improved by: (a) reducing the probability of an event and (b) lessening the severity of the outcome should an event occur. The current study is part of a project on improving the crash safety of lithium-ion batteries.

1.2 DETAILS OF DEVELOPMENT OF DYNAMIC AND IMPACT ANALYSIS OF E-BIKE BATTERY PACK

1.1.5 LITERATURE REVIEW

However, the problem of intermittency affects all renewable energy resources. Use of battery packs to add an energy buffer and increase flexibility of the electric grids is considered a reliable as well as a sustainable solution for the problem of intermittency associated with renewable energy sources. Also, battery-powered vehicles have the potential to substantially cut the greenhouse gas emissions from the transport sector. Electrification of transportation sector is thus integral to the long-term climate control policies of all nations [2]. Finite element analysis considering packaging efficiency of innovative battery pack designs Roland Uerlich, et al [5] The rectangular packs were found to be advantageous in the case of volumetric efficiency, as it is not leaving any void space, but even so, the hexagonal geometry is showing an upper hand while considering the space occupancy rate, in which it can accommodate more number of cells than a similar weighed rectangular module. Ultimately, the overall effect of packaging efficiency demonstrated that the hexagonal is superior to other profiles. Yongjun, et al [6] The results show that the weight of the bottom shell and lifting ears was reduced by 2.9 kg (20.6%) and 0.578 kg (8.2%), respectively. The total weight of the lower battery pack enclosure was reduced by 6.6%, while the crashworthiness performance increased. Junyuan Zhang et al [7] This paper uses a conventional fuel vehicle P5 as a prototype for modified design of a BEV EP5. Firstly, this paper determines the traction battery pack layout and designs floor preliminary based on the characteristics of EP5. Then topology optimization based on ESL method under multiple static and dynamic load cases is used to design EP5 BIW. Finally, 100% frontal impact and side impact load cases are used to verify the modification effect of EP5. The results show that compared with original vehicle P5, the improved BEV EP5 effectively strengthens crashworthiness while reducing weight. James Michael Hooper, et al [8] This paper describes the underpinning theory and experimental method employed when using the impulse excitation technique to quantify the natural frequencies and mode shapes of a commercially available 25 Ah Nickel Manganese Cobalt Oxide (NMC) Laminate Pouch Cell. Shashank Arora, et al [3] Amongst several factors, safety and reliability of battery packs present the highest challenges to large scale electrification of public and private transportation sectors. parameter and two cell number parameters) are extracted to describe the packing modes, packing density and sizes of the module.

1.1.6 PROBLEM STATEMENT

In an electric vehicle (EV), thermal runaway, vibration or vehicle impact can lead to a potential failure of lithium-ion (Li-ion) battery packs due to their high sensitivity to ambient temperature, pressure and dynamic mechanical loads. Amongst several factors, safety and reliability of battery packs present the highest challenges to large scale electrification of private transportation sectors. Electric Vehicles are being developed for newer application the battery pack for these vehicles are subjected to higher dynamic loading and random vibrations due to typical Indian road condition, which results in the larger deformations of pack and cells placed inside the pack. these deformations can cause the short circuit of batteries and thermal runaway of the battery pack. Hence the battery packs must be analyzed for strength, deformation.

1.1.8 METHODOLOGY

The method by which the objectives of the project can be achieved is as follows:

MINI PROJECT:

- **LITERATURE SURVEY REGARDING BATTERY:** This step involves studying regarding batteries different types of batteries available in market different voltage and capacity of each cell and pack.
- **DESIGN A BATTERY PACK FOR E-BIKE FOR HIGH END APPLICATION:** vibrations ambient temperature. Cell-to-cell variations. Auxiliary load. Customer usage is main reason for battery failure and thermal runaway even short circuit so proper battery should be selected according to specified requirement and a battery pack to protect from these failures so literature survey on these concept according to that proper motor is selected.

MAJOR PROJECT:

- Static and Dynamic analysis (vibration on of Li-ion battery):
- Thermal analysis on Li-ion battery:
- Validation of the Results

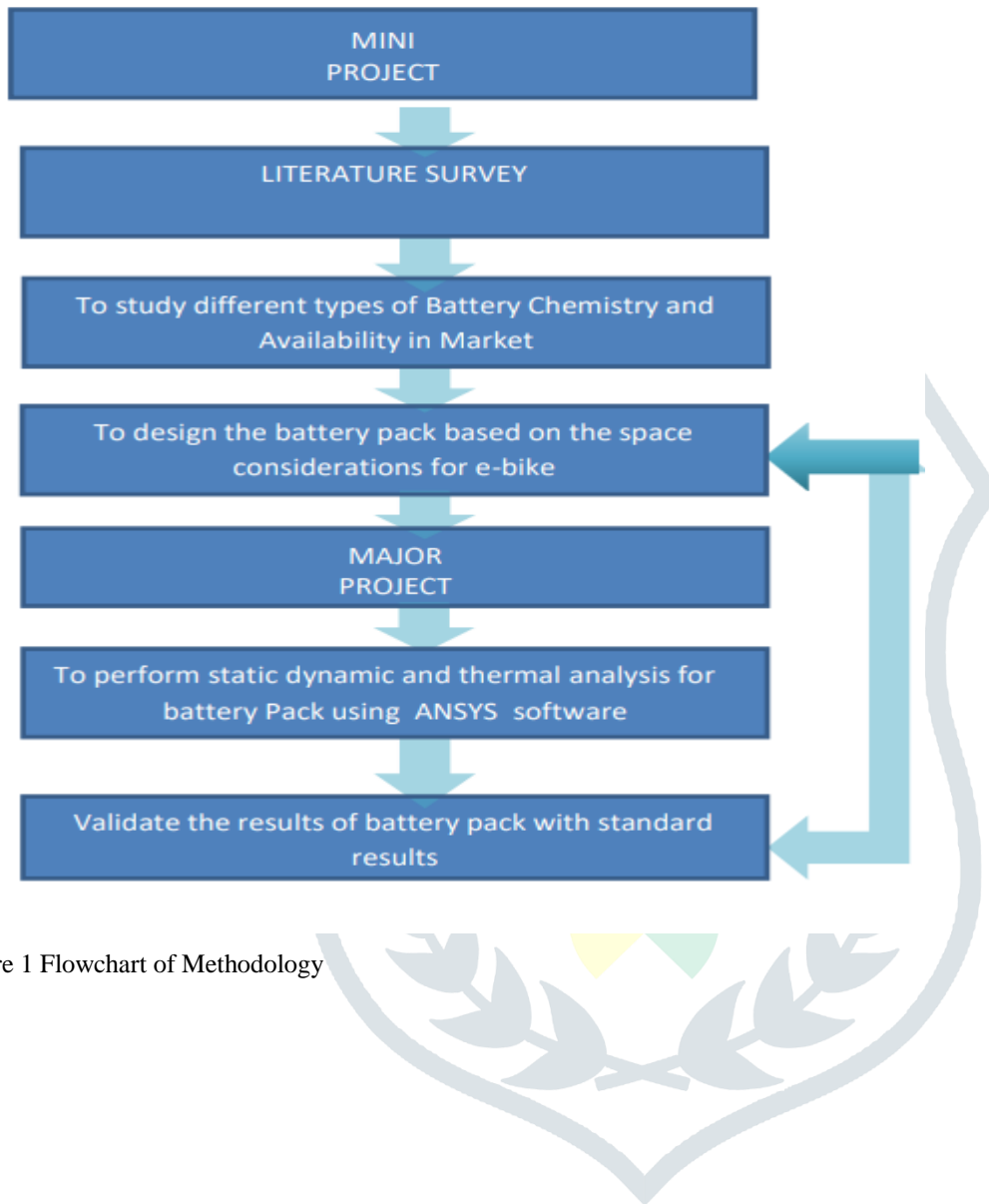

Figure 1 Flowchart of Methodology

CHAPTER 2

2.1 THEORY AND CONCEPT OF DEVELOPMENT OF DYNAMIC AND IMPACT

ANALYSIS OF E-BIKE BATTERY PACK

BATTERY ELECTRIC VEHICLE WORKS

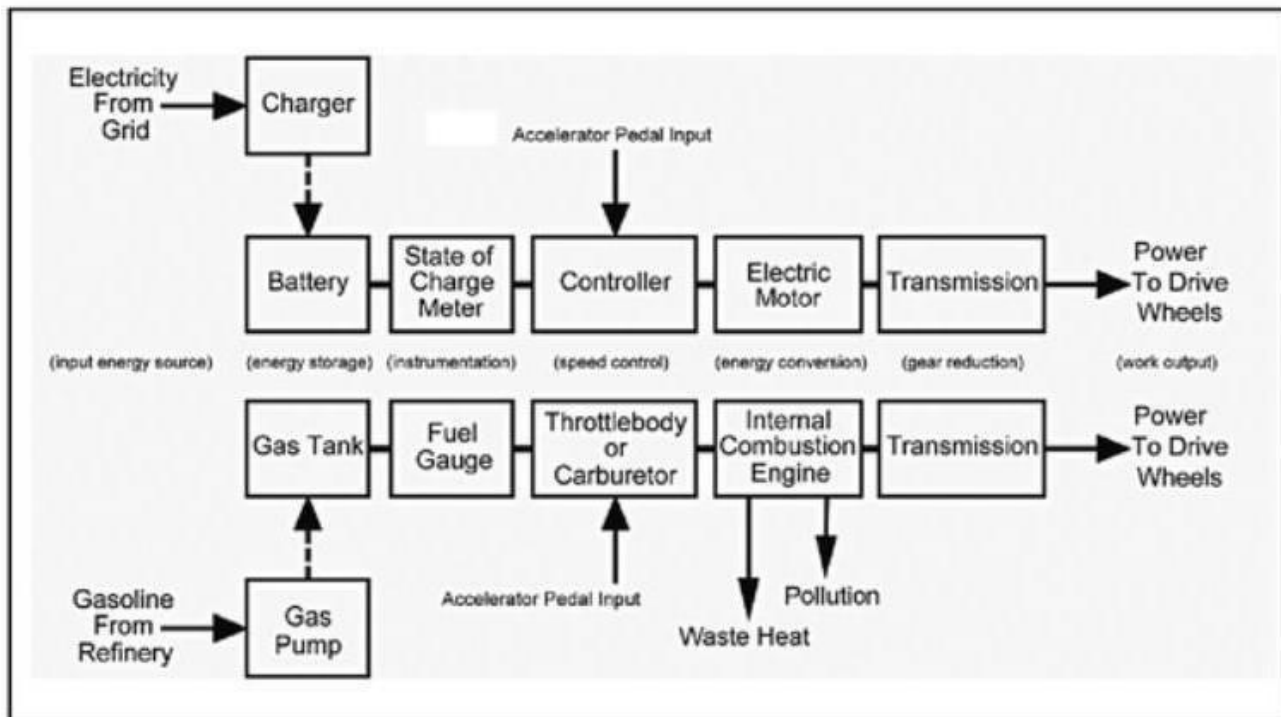

Figure 2 EV Architecture of EV

The drive train consists of three major subsystems: electric motor propulsion, energy source, and auxiliary. The electric propulsion subsystem is comprised of a vehicle controller, power electronic converter, electric motor, mechanical transmission, and driving wheels. The energy source subsystem involves the energy source, the energy management unit, and the energy refueling unit. The auxiliary subsystem consists of the power steering unit, the hotel climate control unit, and the auxiliary supply unit. Based on the control inputs from the accelerator and brake pedals, the vehicle controller provides proper control signals to the electronic power converter, which functions to regulate the power flow between the electric motor and energy source. The backward power flow is due to the regenerative braking of the

E-Bikes Market

Market Growth Will Accelerate at a CAGR (2022-2030)

10.4%

MARKET SIZE

2022
\$40,664 Million

2030
\$89,736 Million

North America is Expected to Progress at CAGR of

14.6%

GROWTH DRIVERS

- Cost-efficiency and environment-friendliness
- Government support and incentives
- Rising health concerns, increasing urbanization rate
- Growing infrastructure in various countries

PRESCIENT & STRATEGIC INTELLIGENCE

Where knowledge inspires strategy

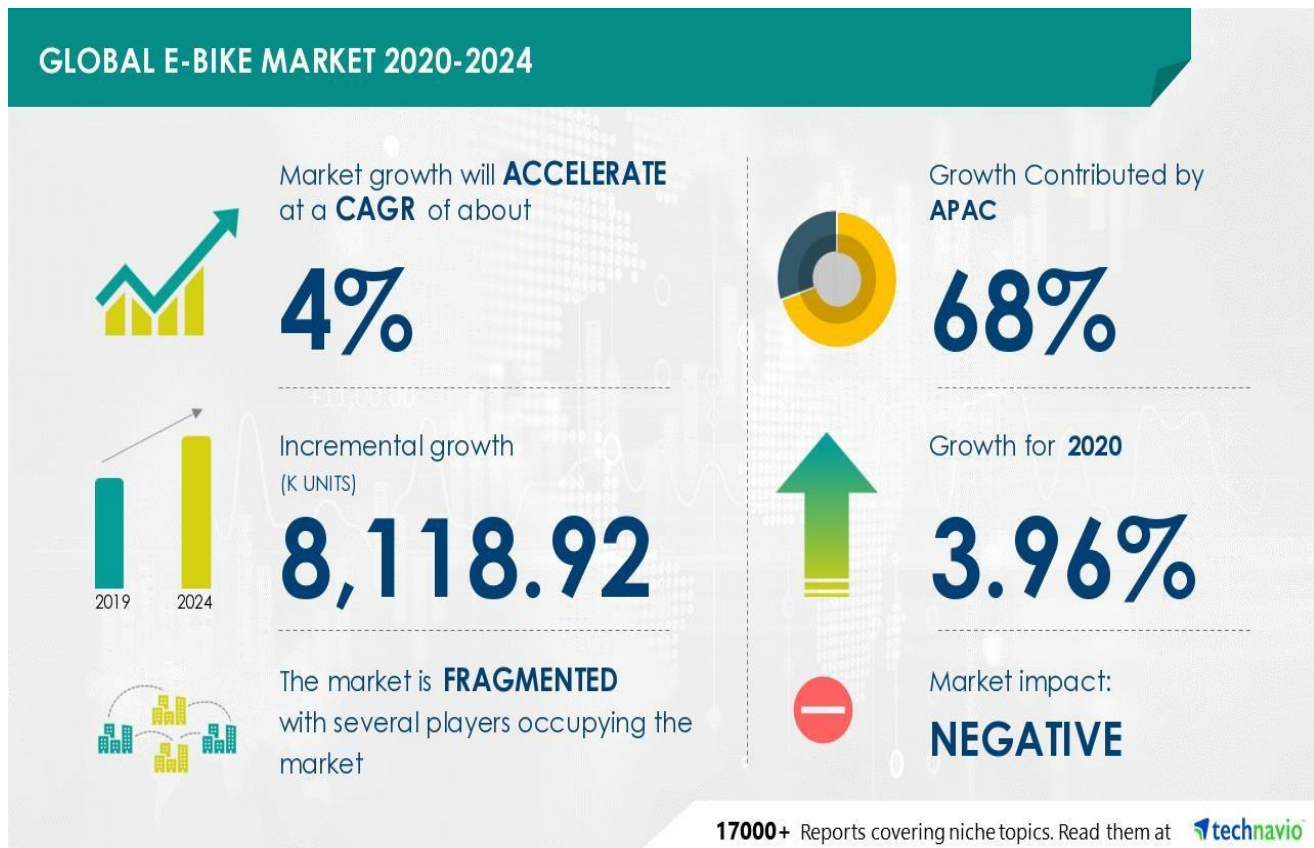

EV and this regenerated energy can be restored to the energy source, provided the energy source is receptive.

2.2 BATTERY INTRODUCTION:

Lithium batteries have existed in various forms since the 1970's, and innovations in the 80's and 90's have led to the familiar lithium battery cells that we know today. Current research on lithium batteries has produced battery cells capable of extreme performance, for example, 100% recharging in just a few seconds. However, these current advances are strictly experimental and won't see commercialization for many years, potentially decades. The information in this book covers the types of lithium batteries that are commercially available today and will likely remain available well into the future.

2.2.1 HOW LITHIUM BATTERY CELLS WORK

Despite undergoing years of research and development, the electrical and chemical processes that allow lithium battery cells to function is actually fairly simple. As lithium-ion batteries are by far the most common form of lithium battery cells, we'll take a look at how a typical cell works here.

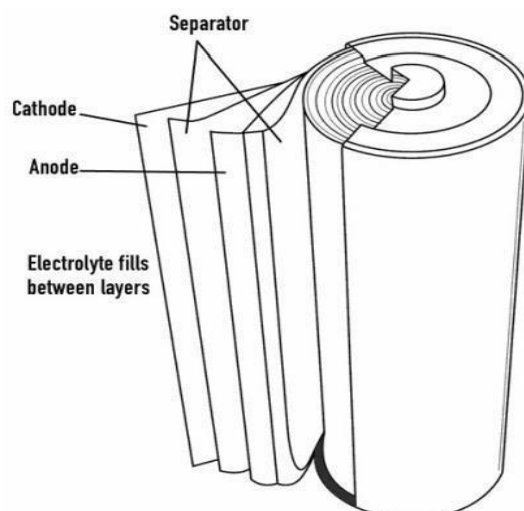

Figure 3 parts of cell

A LITHIUM-ION CELL IS COMPOSED OF FOUR MAIN PARTS:

- CATHODE (OR POSITIVE TERMINAL)
- ANODE (OR NEGATIVE TERMINAL)
- ELECTROLYTE
- POROUS SEPARATOR

The cathode varies between different types of cells but is always a lithium compound mixed with other materials. The anode is almost always graphite, and sometimes includes trace amounts of other elements. The electrolyte is generally, an organic compound containing lithium salts to transfer lithium ions. The porous separator allows lithium ions to pass through itself while still separating the anode and cathode within the cell.

When the cell is discharged, lithium ions move from the anode to the cathode by passing through the electrolyte. This discharges electrons on the anode side, powering the circuit and ultimately any device connected to the circuit. This process is demonstrated in the diagram below. When the cell is recharged, this process is reversed and the lithium ions pass back from the cathode to the anode, which is opposite to the diagram above

2.2.2 SYSTEM BOUNDARIES FOR EV BATTERY PACK

In the case of an EV battery pack, which is essentially a parallel and series combination of multiple electrochemical cells, interactions with the external environment can happen through several interfaces identified

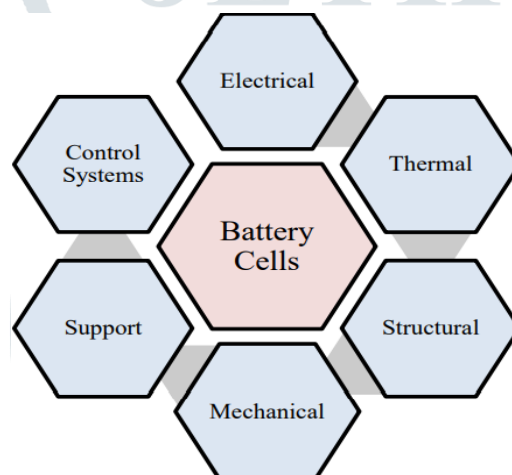

Figure 4 System boundary interface for a battery pack

The figure shows a chemical system in the form of a combination of battery cells trading energy with its environment via various interfaces. A brief description of each of these interfaces is provided below.

- MECHANICAL.** This interface represents all the mechanical design features, including cell spacers, damping pads, pressure relief or exhaust valves and seals/gaskets that have been integrated in the battery pack, mainly for safety reasons.
- STRUCTURAL.** A battery pack needs to be contained in a case with a cover to protect it from the effects of humidity, dirt and other environmental factors. In addition, vibration isolation and high crash-worthiness are necessary. Consequently, structural features such as end-plates, tie-rods and cross-members are provided to function as protective members in the battery pack.
- THERMAL.** The control of the Li-ion battery cell temperature between 25 °C and 30 °C and a uniform thermal distribution across the Li-ion battery pack are required to maximize the energy capacity. To ensure this, a thermal management system including a fluid transfer duct, cooling/heating fluid, insulation coating and auxiliary systems such as fans, pumps, heat exchangers is usually integrated with the battery pack.
- ELECTRICAL.** A battery pack generates current at a certain voltage to meet the power requirements of an EV drive-cycle. This power is transferred through an electrical circuit comprising bus bar and cables, fuse, circuit breakers, contactors and relays to the EV driveline.

- E. **CONTROL SYSTEMS.** In battery management systems, sensors for measuring voltage, current, pressure, temperature and humidity are employed to monitor and regulate the state of the battery pack.
- F. **SUPPORT.** An EV battery pack is generally assembled in the vehicle through mounting brackets and axles, which assist in achieving the required degree of vibration isolation for reliable operation. Support from the chassis and vehicle body increases the overall crashworthiness. Similarly, the vehicle floor panel and seats provide isolation of the high voltage components from the passenger cabin.

CHAPTER 3

PRODUCT REQUIREMENT SPECIFICATION OF DEVELOPMENT OF DYNAMIC AND IMPACT ANALYSIS OF E-BIKE BATTERY PACK

3.1 OVERALL DESCRIPTION OF VEHICLE MOVEMENT

The forces acting on a vehicle moving up a grade. The tractive effort, F_t , in the contact area between tires of the driven wheels and the road surface propels the vehicle forward. It is produced by the power plant torque and is transferred through transmission and final drive to the drive wheels. While the vehicle is moving, there is resistance that tries to stop its movement. The resistance usually includes tire rolling resistance, aerodynamic drag, and uphill resistance. According to Newton’s second law, vehicle acceleration can be written as where V is vehicle speed, ΣFt is the total tractive effort of the vehicle, ΣFtr is the total resistance, Mv is the total mass of the vehicle, and δ is the mass factor, which is an effect of rotating components in the power train.

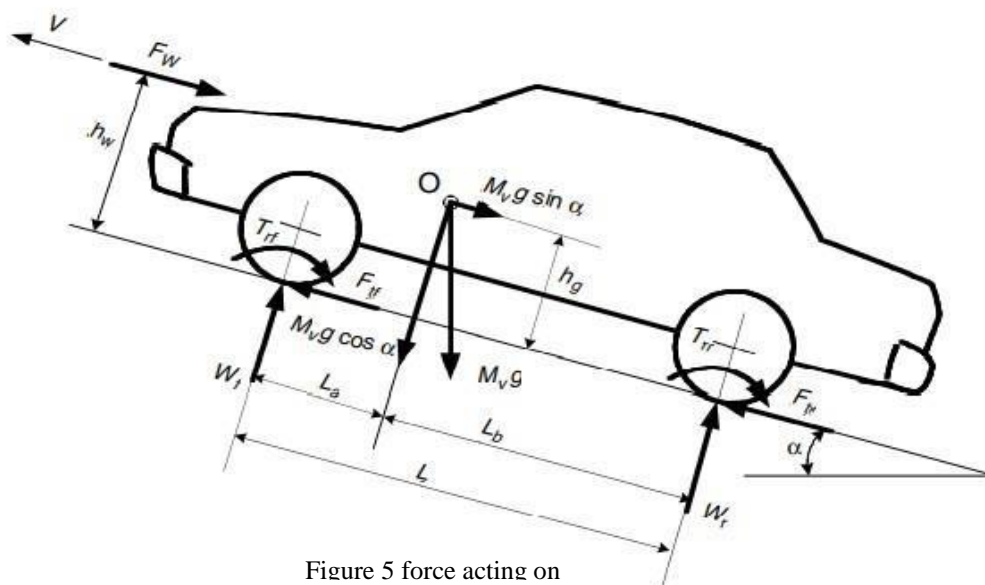
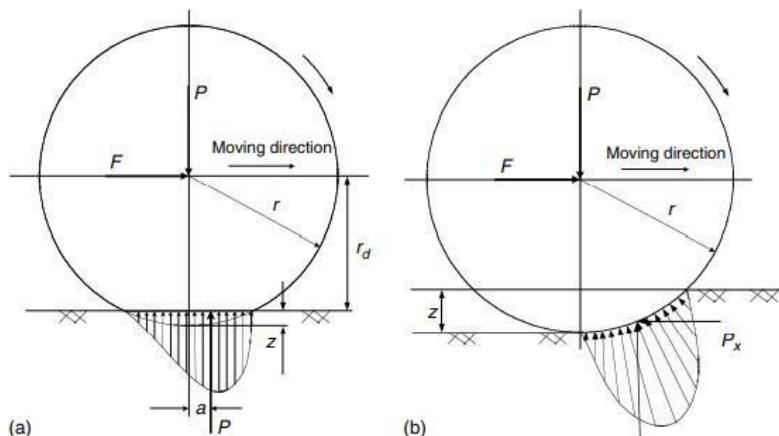

Figure 5 force acting on

3.1 ROLLING RESISTANCE

The rolling resistance of tires on hard surfaces is primarily caused by hysteresis in the tire materials. This is due to the deflection of the carcass while the tire is rolling. The hysteresis causes an asymmetric distribution of ground reaction forces. The pressure in the leading half of the contact area is larger than that in the trailing half, as shown in Figure(a). This phenomenon results in the ground reaction force shifting forward. This forwardly shifted ground reaction force, with the normal load acting on the wheel centre, creates a moment, that opposes the rolling of the wheel. On soft surfaces, the rolling resistance is primarily caused by deformation of the ground surface as shown in Figure (b). The ground reaction force almost completely shifts to the leading half. The moment produced by the forward shift of the resultant ground reaction force is called the rolling resistant moment,



Rolling Resistance Coefficients

Conditions	Rolling resistance coefficient
Car tires on concrete or asphalt	0.013
Car tires on rolled gravel	0.02
Tar macadam	0.025
Unpaved road	0.05
Field	0.1–0.35
Truck tires on concrete or asphalt	0.006–0.01
Wheels on rail	0.001–0.002

Table 1 Rolling resistance coefficients

3.1.2 AERODYNAMIC DRAG:

A vehicle traveling at a particular speed in air encounters a force resisting its motion. This force is referred to as aerodynamic drag. It mainly results from two components: shape drag and skin friction. Shape drags: The forward motion of the vehicle pushes the air in front of it. However, the air cannot instantaneously move out of the way and its pressure is thus increased, resulting in high air pressure. In addition, the air behind the vehicle cannot instantaneously fill the space left by the forward motion of the vehicle. This creates a zone of low air pressure. The motion has therefore created two zones of pressure that oppose the motion of a vehicle by pushing it forward (high pressure in front) and pulling it backward (low pressure in the back) as shown in Figure 6. The resulting force on the vehicle is the shape drag. Skin friction: Air close to the skin of the vehicle moves almost at the speed of the vehicle

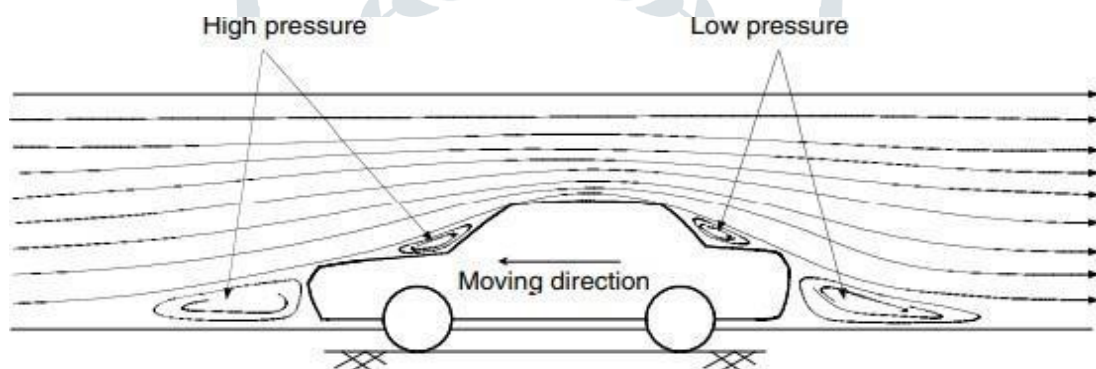

while air far from the vehicle remains still. In between, air molecules move at a wide range of speeds. The difference in speed between two air molecules produces a friction that results in the second component of aerodynamic drag.

3.1.3 GRADING RESISTANCE:

When a vehicle goes up or down a slope, its weight produces a component, which is always directed to the downward direction, as shown in Figure 7. This component either opposes the forward motion (grade climbing) or helps the forward motion (grade descending). In vehicle performance analysis, only uphill operation is considered. This grading force is usually called grading resistance.

Table 2 Indicative drag coefficients for different body shapes

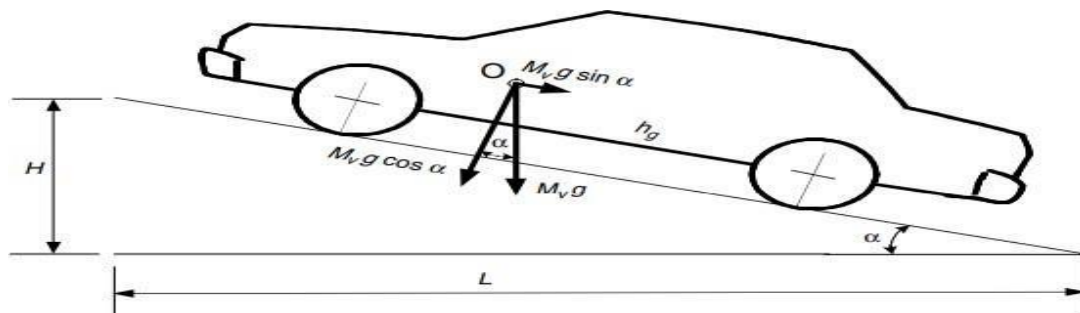

Figure 7 Automobile climbing a grade

CHAPTER 4

CONCLUSION

The Mini project objectives are completed and are fulfilled by calculating motor sizing and different analysis to be performed on battery pack.

- In Mini project vibrations ambient temperature. Cell-to-cell variations. Auxiliary load. Customer usage is main reason for battery failure and thermal runaway even short circuit so proper battery should be selected according to specified requirement and a battery pack to protect from these failures so literature survey on these concept according to that proper motor is selected.
- In Major project To design the battery pack based on the space considerations for e- bike to perform static dynamic and thermal analysis for battery Pack using ANSYS software Validate the results of battery pack with standard results.

REFERENCES

- 1) Alper Nabi Akpolat et al “Li-ion-based Battery Pack Designing and Sizing for Electric Vehicles under Different Road Conditions” IEEE 2020
- 2) Shashank Arora et al “Review of mechanical design and strategic placement technique of a robust battery pack for electric vehicles” Renewable and Sustainable Energy Reviews 60 (2016) 1319–1331
- 3) Akhil Garg et al “Design optimization of battery pack enclosure for electric vehicle” Structural and Multidisciplinary Optimization Springer-Verlag GmbH Germany, part of Springer Nature 2018
- 4) Juner Zhu et al “A review of safety-focused mechanical modelling of commercial lithium- ion batteries” Journal of Power Sources 378 (2018) 153–168
- 5) Yongjun Pan et al “Crush and crash analysis of an automotive battery-pack enclosure for lightweight design” International Journal of Crashworthiness Oct 2020.
- 6) Junyuan Zhang et al “Topology optimization for crashworthiness and structural design of a battery electric vehicle” International Journal of Crashworthiness May 2020
- 7) James Michael Hooper et al “Experimental modal analysis of lithium-ion pouch cells” Journal of Power Sources 285 (2015) 247-259
- 8) Paolo Cicconi et al “Thermal analysis and simulation of a Li-ion battery pack for a lightweight commercial EV” Applied Energy 192 (2017) 159–177
- 9) Ilya Avdeev et al “Structural analysis and experimental characterization of cylindrical lithium-ion battery cells subject to lateral impact” Journal of Power Sources 271 (2014) 382- 391
- 10) Binghe Liu et al “Mechanical integrity of 18650 lithium-ion battery module: Packing density and packing mode” Engineering Failure Analysis 91 (2018) 315–326