



DESIGN AND PERFORMANCE ANALYSIS OF LVDT FOR SMALL DISPLACEMENT

¹Nisarg Gajjar, ¹Karnrajsinh Rana, ¹Shrutiben Shah, ¹Akshaykumar Suthar,

¹B. Tech Instrumentation and Control Engineering (Semester-VIII)

¹Faculty of Technology,

¹Dharmsinh Desai University, Nadiad, India.

Under Internal Guidance of

²Shweta Gaur,

²Assistant Professor, Department of Instrumentation and Control Engineering,

²Faculty of Technology,

¹Dharmsinh Desai University, Nadiad, India.

Under External Guidance of

³Rajeev Dubey,

³Chairman and Managing Director,

³Quantum Age Tech Solutions Pvt. Ltd, Vadodara, India.

Abstract: The Linear Variable Differential Transformer/Transducer (LVDT) sensor converts the linear movement of the object the LVDT is coupled with into a variable corresponding electrical signal proportional to that movement. The design and development of the LVDT sensor, as well as performance analysis, are included in this research article. This research paper reflects how different types of core material, different types of wire gauge, input voltage, and input frequency influence the output voltage. The LVDT range is 0 to 2 mm for a minor scale specification of 0.1 mm. With diverse core materials, input voltage, and frequency, we investigate the accuracy and repeatability of Voltage Output measurements.

Index Terms: Linear Variable Differential Transformer (LVDT), Magnetic Core material, Displacement measurement

1. INTRODUCTION

The development of sensors is developing with the technology advancing with advancing systems and materials. The Requirements of sensors and sensor technologies are not limited only to the industrial field but also penetrated in other fields, such as automotive, processing technology, building, medical, communication, information technology, and other areas. Linear Variable Displacement Transformer (LVDT) is a transformer used to measure linear displacement.

LVDTs are absolute linear position displacement transducers with infinite running cycles if used correctly. LVDT converts the linear moment of the core into the voltage form with proper magnitude and phase. LVDT operation does not require any physical connection between the moving part and the coil, but instead, it works on the mutual inductance concept.

There are two types of LVDTs are available in the market. DC LVDT and AC LVDT. In the DC LVDT, DC is used to power the coil, while in AC LVDT, AC is used in biasing.

1.1. BLOCK DIAGRAM



Fig.1.1 Block Diagram

1.1.1. SINE WAVE GENERATOR CIRCUIT

The sine wave generator input voltage is $\pm 12V$.
 The sine wave generator output voltage is $11V_{pp}$.
 The sine wave generator output frequency is 3 kHz.

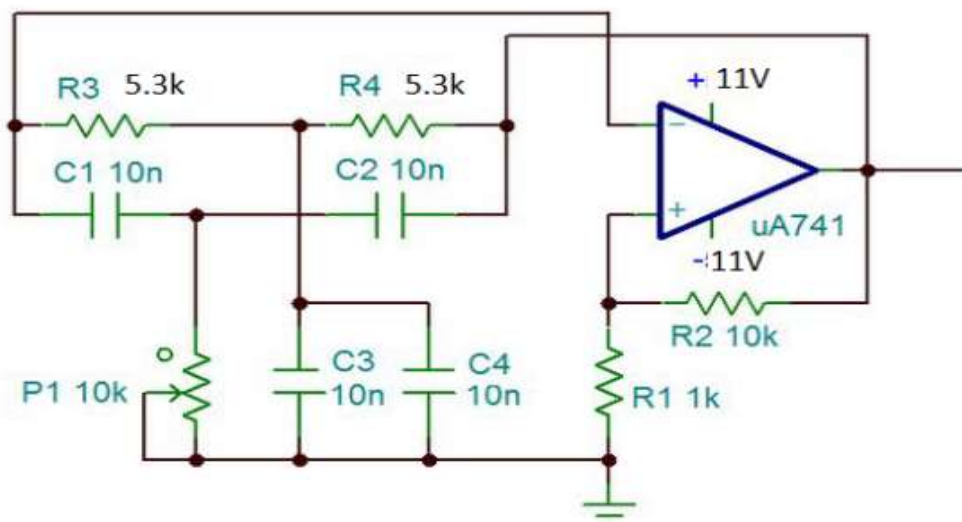

Fig. 1.1.1 Sine wave Generator Circuit

1.1.2. LVDT TESTING BOARD

It is designed for testing LVDT and getting the output. It has a screw mechanism for the linear movement of the Plunger, which is having core attached. Another plunger side is connected with a dial gauge for displaying core movement.

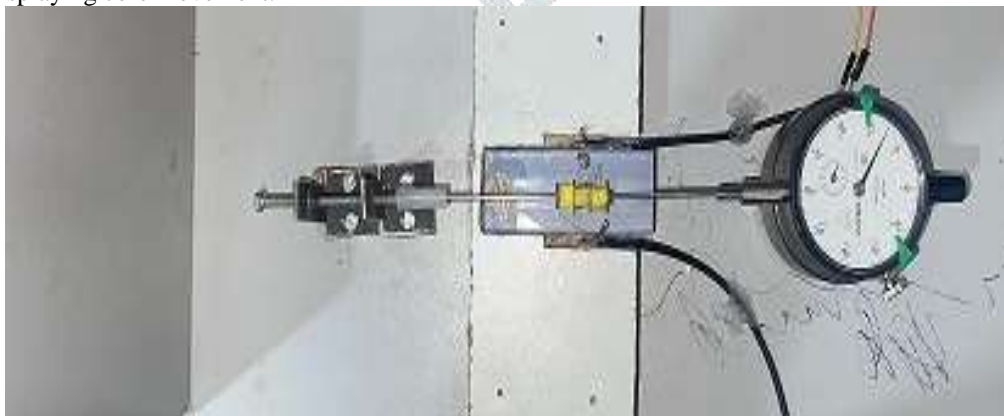

Fig. 1.1.2. LVDT Testing Board

1.1.2.1. CONSTRUCTION DETAILS

The significant parts of LVDT are coil form, coil, and core.

There is one primary and two secondary coils present in the LVDT. Coil forms are used to hold a specified number of turns. Acrylic or plastic as the material of Coil form can be used. Acrylic is a transparent plastic material having better strength, stiffness, and optical clarity.

An LVDT core is usually a cylinder made from a permeable magnetic material that provides inductive coupling between the primary and secondary coils.

1.1.2.2. SELECTION OF CORE MATERIAL

There are two types of cores available for LVDT.

- (i) Ferromagnetic: Most of the ferromagnetic materials are metals. Common examples of ferromagnetic substances are Iron, Cobalt, Nickel.
- (ii) Ferrimagnetic: It is a material with populations of atoms with opposing magnetic moments, as in antiferromagnetism. These moments are unequal in magnitude for ferrimagnetic materials, so a spontaneous magnetization remains. The core material selection depends on permeability, thermal expansion coefficient, density, relative permeability, losses, and cost.
For making LVDT, high permeability material with a low thermal expansion coefficient that is lighter in weight and has high relative permeability and lesser losses and cheaper is required.
After observing all of the above parameters, the most suitable core materials were
 - (a) Iron (99.95%)
 - (b) Ferrite (Zn-Ni)

1.1.2.3. SELECTION OF CORE SIZE

Core length is one of the significant parts of LVDT design. Because of this, the core having different sizes is used for getting the better performance of LVDT.

Core 1: - It is the Ferromagnetic material core of Zi-Ni. Its size is 12 mm, which is greater than the length of primary windings.

Core 2: - It is the Ferromagnetic material core of Zi-Ni. Its size is 6 mm, equal to the length of primary windings.

Core 3: - It is the Soft Iron core. Its size is 12 mm, which is greater than the length of primary windings.

1.1.2.4. SELECTION OF TYPE OF WINDINGS

The windings of the transformer are for generating inductance, due to which we can get the output. Windings must be strong enough for withstanding mechanical stress and electrical change in voltages. Several windings are used in transformers; for these LVDTs, a Spiral type of winding is used.

1.1.2.5. ESTIMATION OF NO. OF TURNS

For LVDTs, the Primary coil is an excitation coil, and a Secondary coil is a sensing element.

For calculating number of turns,

$$N_p = \frac{V_{rms} * 108}{4.44 * B * A_c * F * K}$$

Where, N_p = Number of Primary turns

V_{rms} = RMS value of Voltage = 4.23 V

B = Magnetic Flux Density = 1750 Gauss

A_c = Cross sectional Area of Core

F = Excitation Frequency = 3000 Hz

K = Stacking Factor = 0.9

1.2. PROCEDURE OF TESTING

Connect the sine wave generator circuit to the ± 12 V supply. To get a sine wave without clipping, adjust the potentiometer from the sine wave generator circuit. Install the LVDT on the LVDT testing board and set the core to zero. Connect the produced output to the primary coil via coaxial wires for external noise correction. Provide movement to the core through the LVDT testing board screw, and the dial gauge will display analog output. Look at the output waveform in the CRO and take notes. Calculate the accuracy value using the equation. Get the accuracy and repeatability graphs. Examine the charts for several cores.

2. LVDT DESIGN

In this, a total of two LVDTs is designed. The difference between them is that they have different core materials, core lengths, and core wire gauges.

The core length of the Ferrite core and Iron core is greater than the length of primary windings, and the size of the small ferrite core is the same as the length of primary windings.

2.1. LVDT 1 (41 SWG, 2.38 mm core diameter)

For this LVDT, the Specifications of Design are as follows,

Wire Gauge = 41 SWG = 0.118mm

Bobbin Inner Diameter (ID) = 2.38mm

Bobbin Wall Thickness = 0.5mm

Bobbin Outer Diameter (OD) = 2.88mm

Cross-sectional Area of the core (A_c) = $(3.14) * (2.88/2)^2$
= $6.51 \text{ mm}^2 = 0.0651 \text{ cm}^2$

For Finding No of turns,

$N_p = (V_{rms} * 10^8) / (4.44 * B * A_c * F * K)$

Where, N_p = Number of Primary turns

V_{rms} = RMS value of Voltage = 4.23 V

B = Magnetic Flux Density = 1750 Gauss

A_c = Cross sectional Area of Core = 0.0651 cm²

F = Excitation Frequency = 3000 Hz

K = Stacking Factor = 0.9

$N_p = (4.23 * 10^8) / (4 * 1750 * 0.0651 * 3000)$

= 309.44

= 310 Turns

$N_s = 310 + 310$

Layers = 5 layers (In each layer 62 turns are there)

Primary coil Length = 5.15 mm

Secondary coil length = 5.15mm + 5.15mm = 10.30mm

Separators ($SW_1 = SW_2 = SW_3 = SW_4 = 0.5\text{mm}$) = $4 * 0.5 = 2\text{mm}$

Total length of LVDT = 17.45 mm

Output: -

➤ For this LVDT, Core 1 is used. The output graph is as follows,

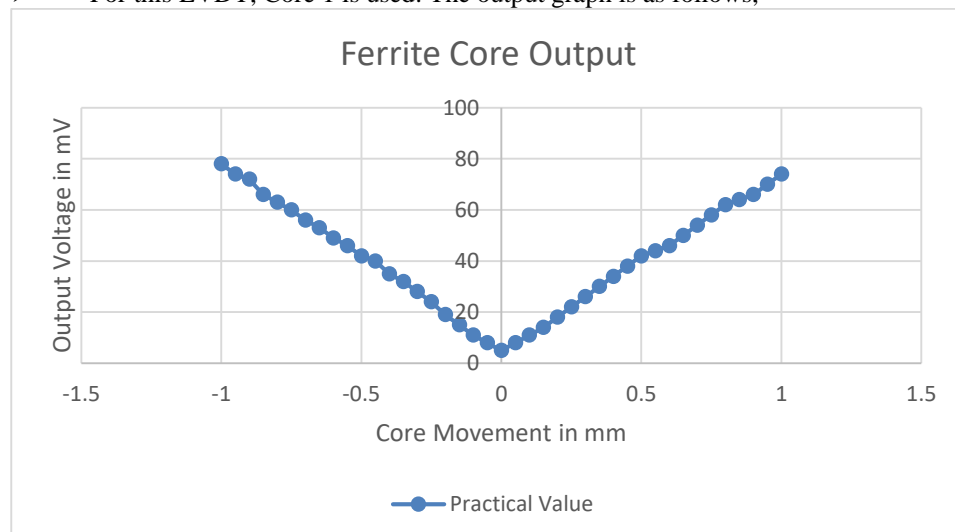

Fig. 2.1.1 Output voltage graph for core 1

From the above graphical representation, we learned that the ferrite Core output is almost linear for the movement of -1 to 1 mm (2mm).

➤ For the above LVDT Core, two is used, gives output voltage as follows,

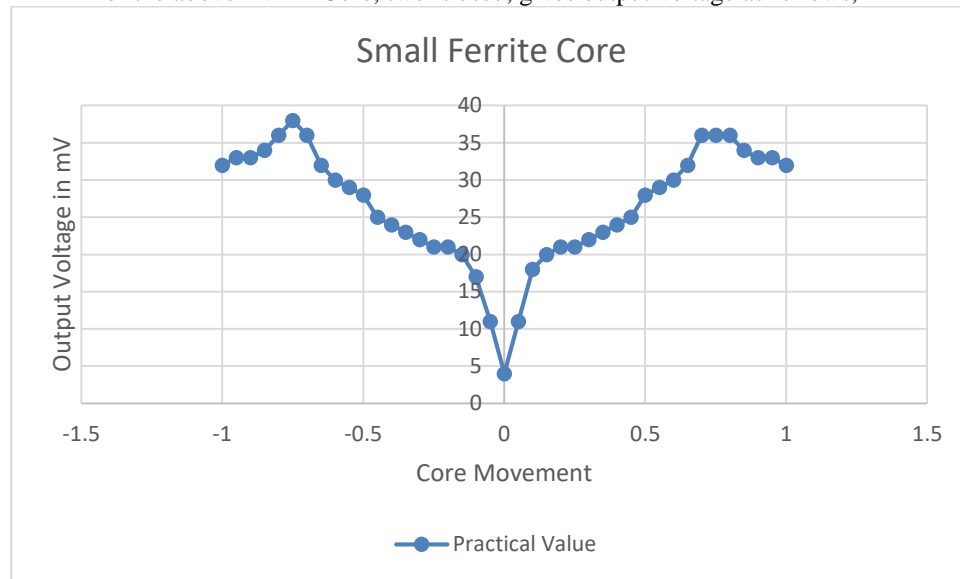
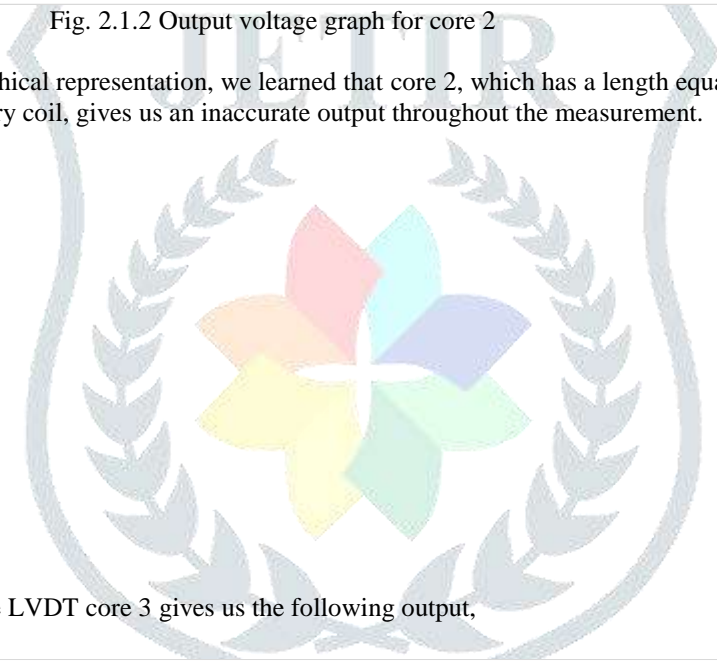

Fig. 2.1.2 Output voltage graph for core 2

From the above graphical representation, we learned that core 2, which has a length equal to the size of the primary coil, gives us an inaccurate output throughout the measurement.



➤ For the above LVDT core 3 gives us the following output,

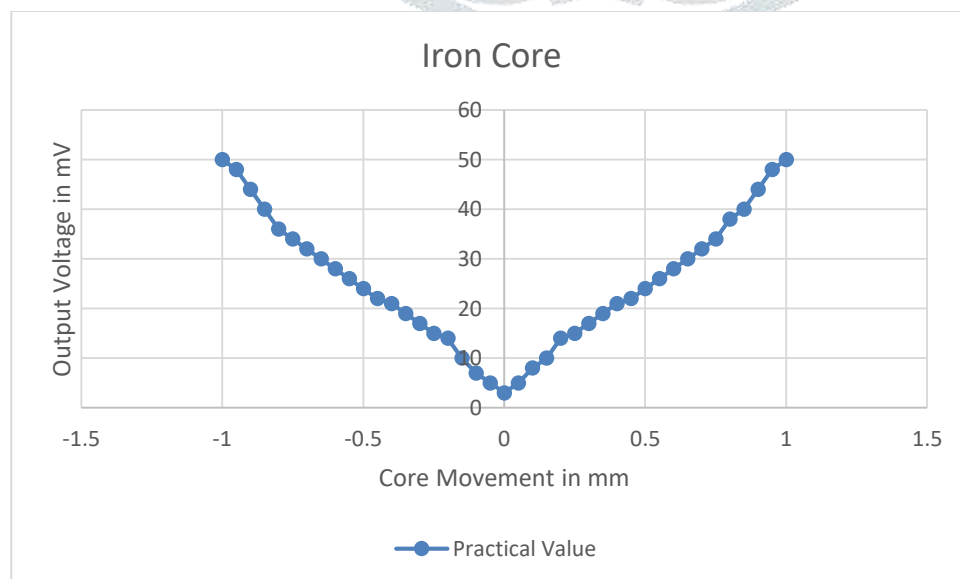

Fig.2.1.3 Output voltage graph for core 3

For the above iron core output, we got to know that the core gives us an almost linear output, but the slope varies.

2.2. LVDT (44 SWG, 2.38 mm core diameter)

For this LVDT, the Specifications of Design are as follows,

Wire Gauge = 44 SWG = 0.0831mm

Bobbin Inner Diameter (ID) = 2.38mm

Bobbin Wall Thickness = 0.5mm

Bobbin Outer Diameter (OD) = 2.88mm

Cross-sectional Area of the core (Ac) = $(3.14) * (2.88/2)^2$
 $= 6.51 \text{ mm}^2 = 0.0651 \text{ cm}^2$

For Finding No of turns,

$N_p = (V_{rms} * 10^8) / (4.44 * B * A_c * F * K)$

Where, N_p = Number of Primary turns

V_{rms} = RMS value of Voltage = 4.23 V

B = Magnetic Flux Density = 1750 Gauss

A_c = Cross sectional Area of Core = 0.0651 cm²

F = Excitation Frequency = 3000 Hz

K = Stacking Factor = 0.9

$N_p = (4.23 * 10^8) / (4 * 1750 * 0.0651 * 3000)$
 $= 309.44$

$= 310$ Turns

$N_s = 310 + 310$

Layers = 5 layers (In each layer 62 turns are there)

Primary coil Length = 5.15 mm

Secondary coil length = 5.15mm + 5.15mm = 10.30mm

Separators (SW1=SW2=SW3=SW4=0.5mm) = 4*0.5 = 2mm

Total coil length of LVDT = 17.45 mm

Output: -

➤ For this, LVDT Core 1 gives us the following output graph,

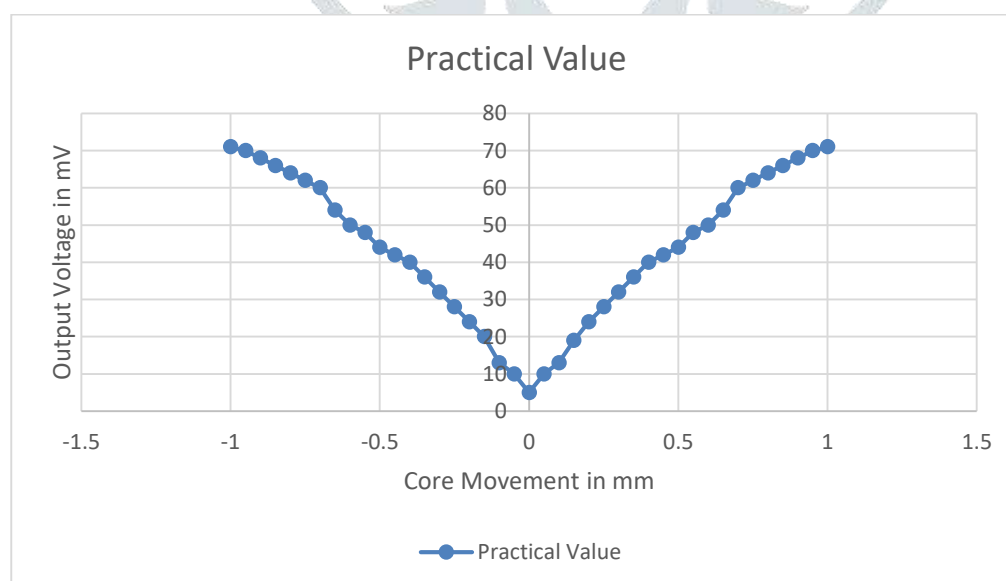

Fig.2.2.1 Output voltage graph of core 1

From the above graphical representation, we got to know that for core 1, the output is almost linear up to 0.7mm positive and negative displacement. After 0.7 mm, the output slope is decreased.

➤ The above LVDT core three is used as a core. The output graph is as follows,

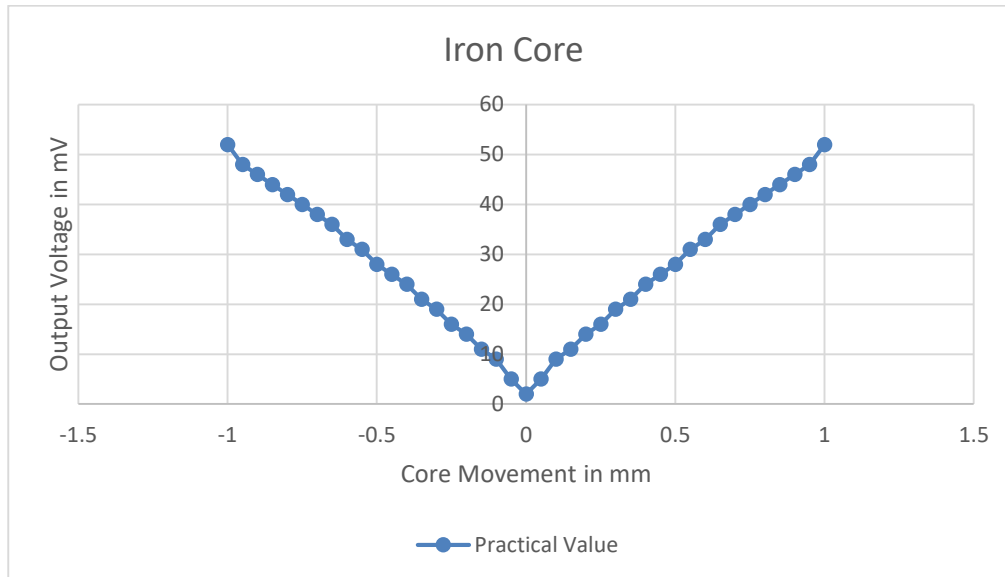

Fig.2.2.2 Output voltage graph for core 3

For the iron core, the graph is linear without deviating from the theoretical value.

3. PERFORMANCE ANALYSIS

Parameters are the primary thing that affects the performance of the LVDT. The following analysis is for two of the main parameters that affect the performance of the same. (1) Accuracy, (2) Repeatability.

3.1. ACCURACY: -

Accuracy means how close or far from the true value of the reading.

$$\text{Accuracy} = \frac{\text{Practical value} - \text{Theoretical value}}{\text{Theoretical value}}$$

3.1.1. For LVDT 1 (41 SWG, 2.38 core diameter)

➤ Core 1

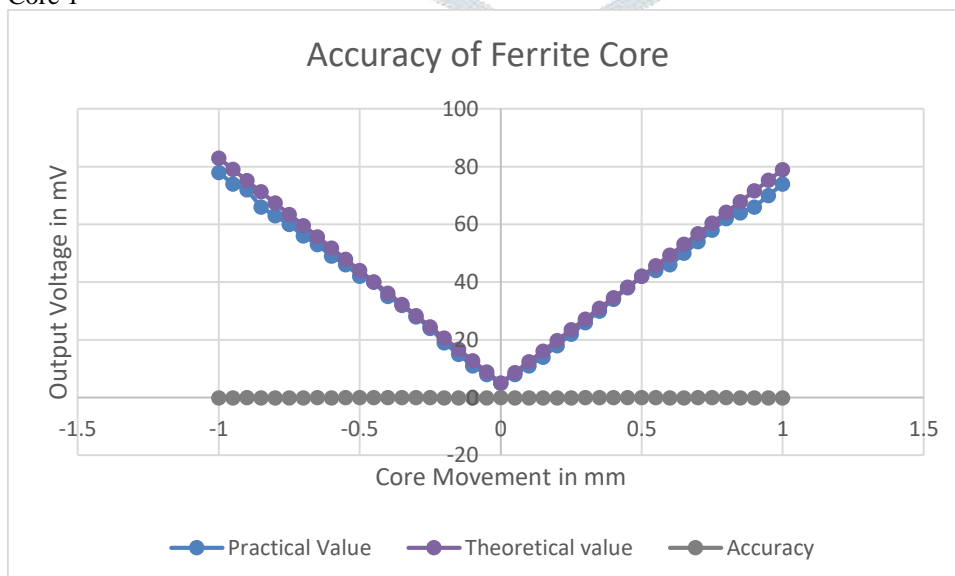

Fig.3.1.1.1 Accuracy graph for core 1

From the above graphical representation, we can get those the practical and theoretical values are almost the same throughout the measurement.

$$\begin{aligned} \text{Average accuracy for Ferrite core} &= \frac{\text{Sum of accuracy at each of the points} \times 100\%}{\text{Total points}} \\ &= \pm 0.0541\% \end{aligned}$$

➤ Core 2

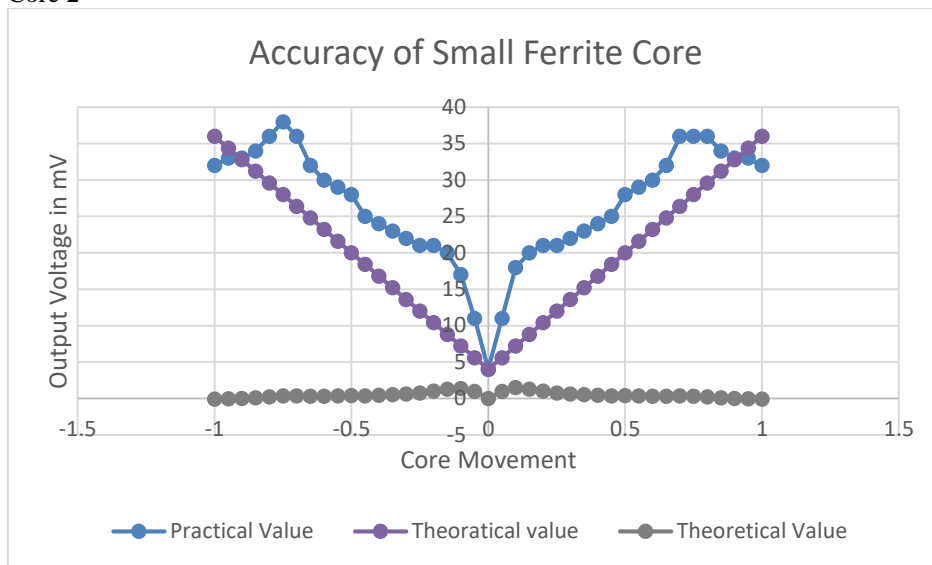

Fig.3.1.1.2 Accuracy graph for core 2

From the above graphical representation, we can get those the practical and theoretical values are not accurate for all the measurements.

$$\begin{aligned} \text{Average accuracy for Small Ferrite core} &= \frac{\text{Sum of accuracy at each of the points} \times 100\%}{\text{Total points}} \\ &= \pm 0.4646\% \end{aligned}$$

➤ Core 3

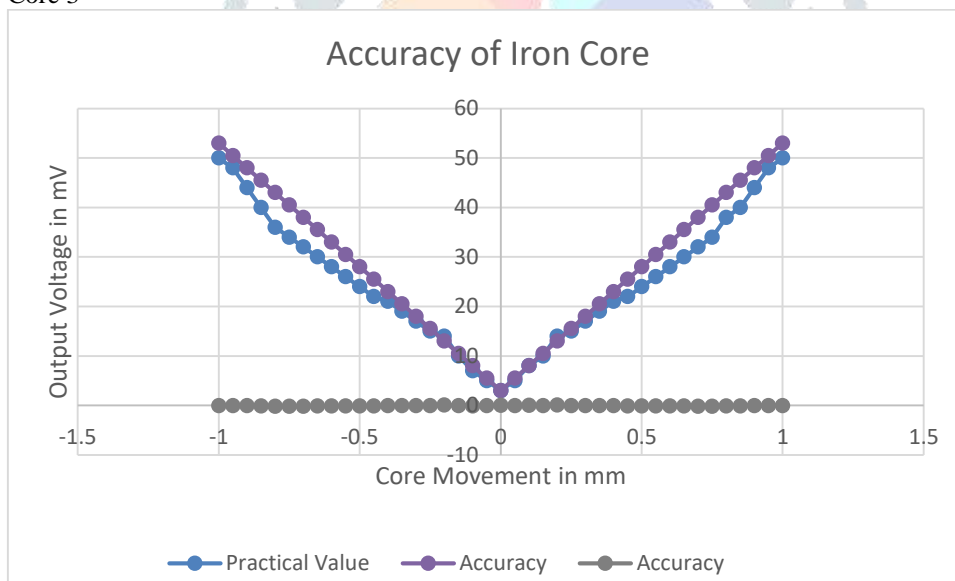

Fig.3.1.1.3 Accuracy graph for core 3

From the above graphical representation, we can get those the practical and theoretical values are the same but not more accurate.

$$\begin{aligned} \text{Average accuracy for Iron core} &= \frac{\text{Sum of accuracy at each of the points} \times 100\%}{\text{Total points}} \\ &= \pm 0.0914\% \end{aligned}$$

3.1.2. For LVDT 2 (44 SWG, 2.38 core diameter)

➤ Core 1

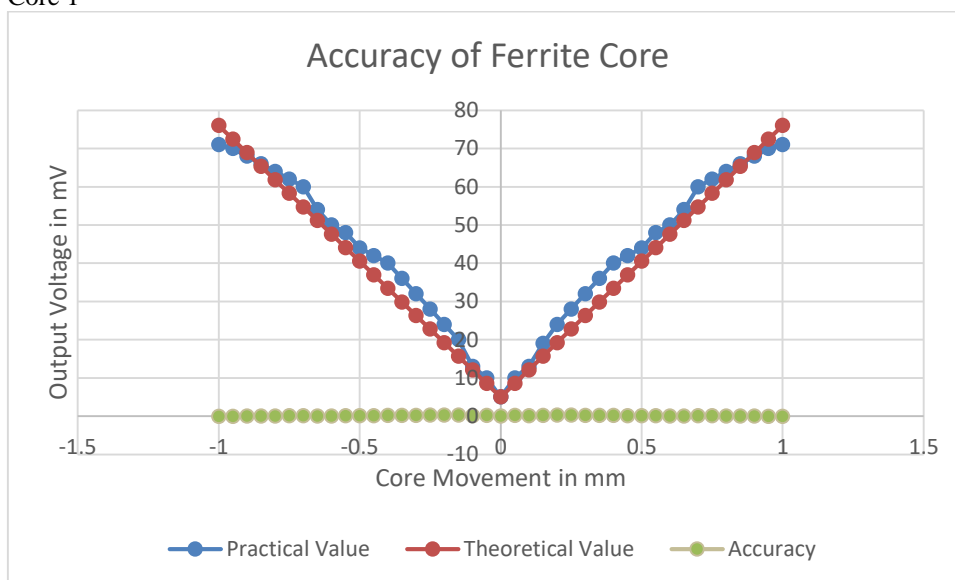

Fig.3.1.2.1 Accuracy graph for core 1

The above graphical representation shows that the practical and theoretical values are different but scatter from the theoretical value.

$$\text{Average accuracy for Ferrite core} = \frac{\text{Sum of accuracy at each of the points} \times 100\%}{\text{Total points}}$$

$$= \pm 0.1026 \%$$

➤ Core 3

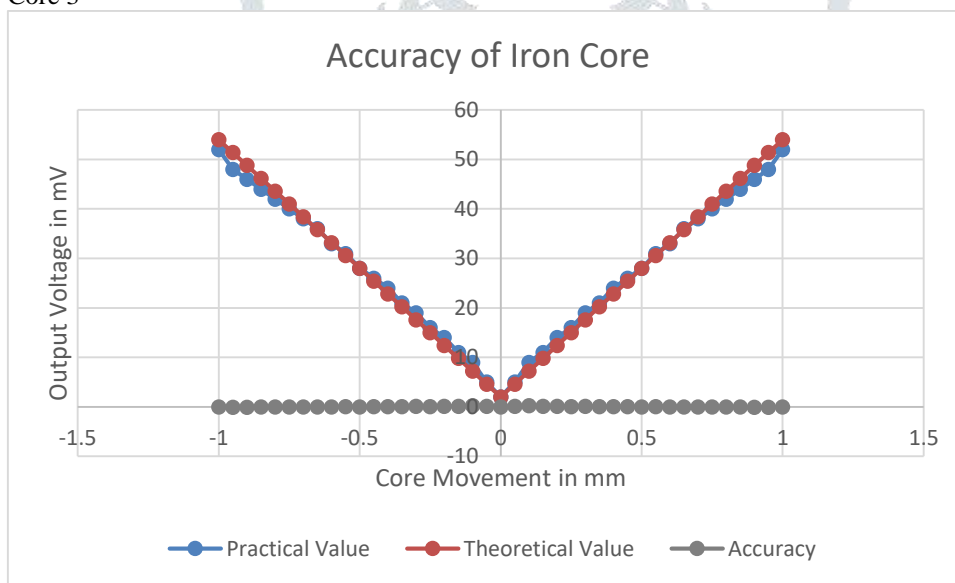

Fig.3.1.2.2 Accuracy graph for core 3

From the above graphical representation, we can get those the practical and theoretical values are the same but have positive and negative errors, so it is inaccurate.

$$\text{Average accuracy for Iron core} = \frac{\text{Sum of accuracy at each of the points} \times 100\%}{\text{Total points}}$$

$$= \pm 0.0284 \%$$

Result: -

From all the above graphs for different core materials and wire gauges of all those LVDTs, we can conclude that ferrite core and Iron core which has a greater length than primary windings, give you the most accurate output.

3.2. REPEATABILITY: -

The variation in which we get successive measurements of the same LVDT taken under the same condition (same observer, location, instrument, procedure) in a short time.

3.2.1. For LVDT 1 (41 SWG, 2.38 core diameter)

➤ Core 1

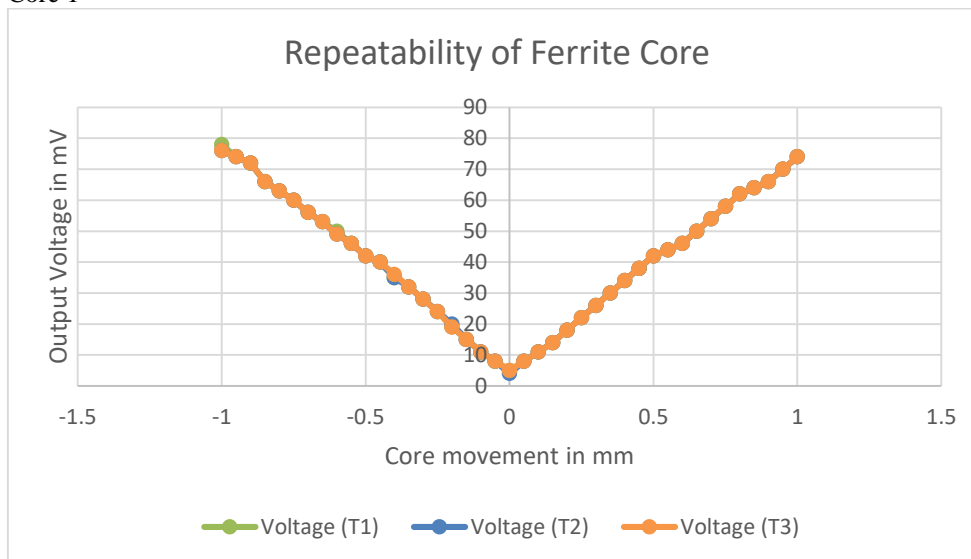

Fig.3.2.1.1 Repeatability graph for core 1

The above graphical representation shows that the graph is almost identical for all three readings, with good repeatability.

➤ Core 2

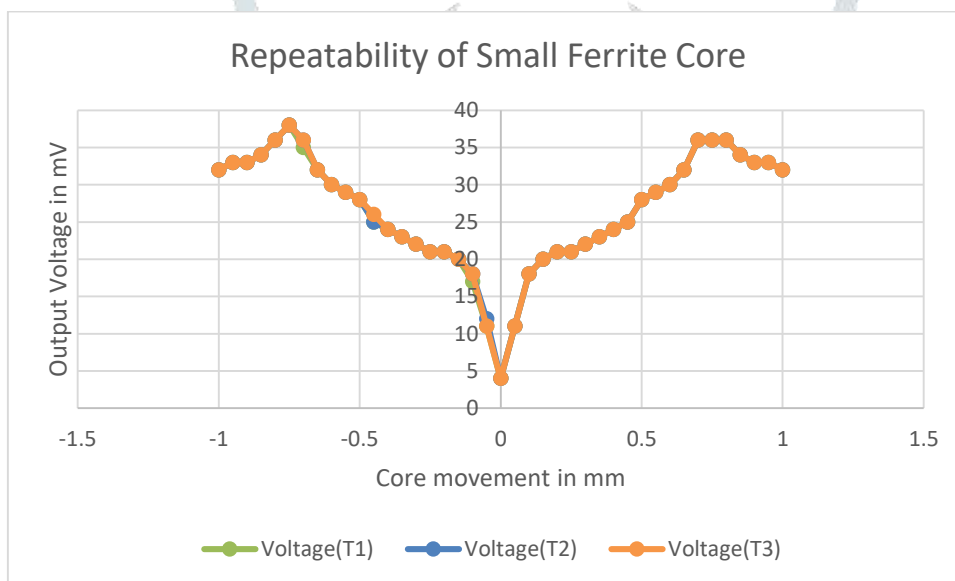

Fig.3.2.1.2 Repeatability graph for core 2

The above graphical representation shows that the graph is almost identical for all three readings, with good repeatability.

➤ Core 3

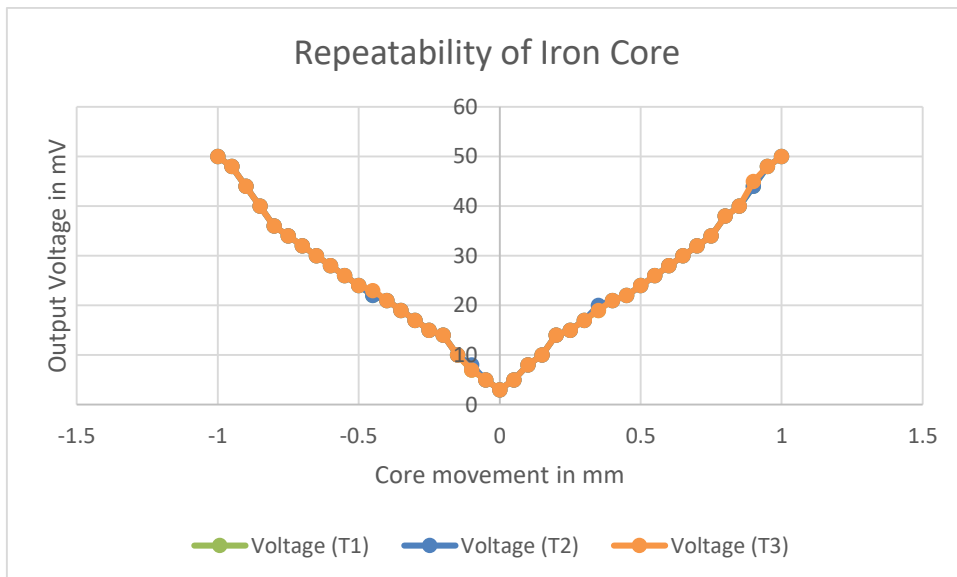

Fig.3.2.1.3 Repeatability graph for core 3

The above graphical representation shows that the graph is almost identical for all three readings, with good repeatability.

3.2.2. or LVDT 2 (44 SWG, 2.38 core diameter)

➤ Core 1

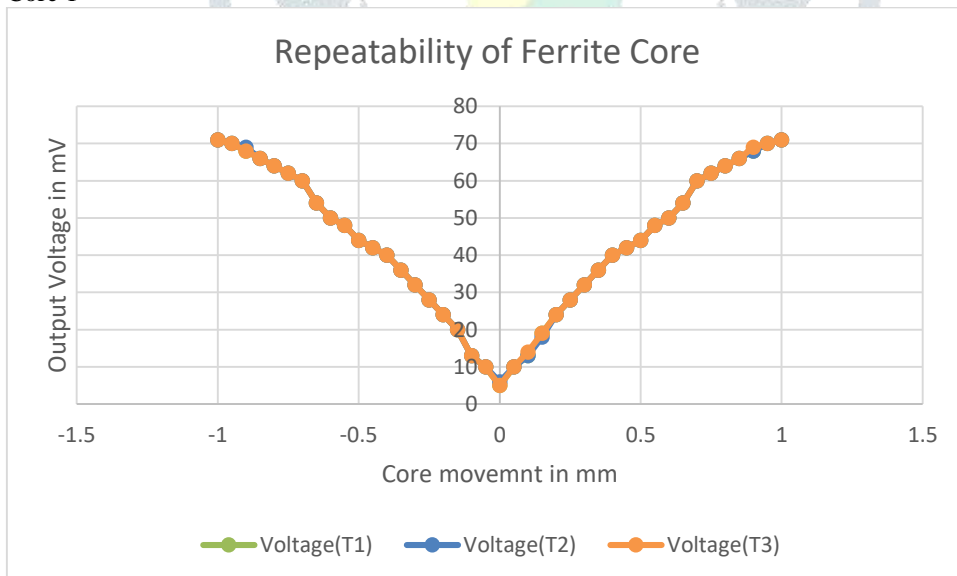

Fig.3.2.2.1 Repeatability graph for core 1

The above graphical representation shows that the graph is almost identical for all three readings, with good repeatability.

➤ Core 3

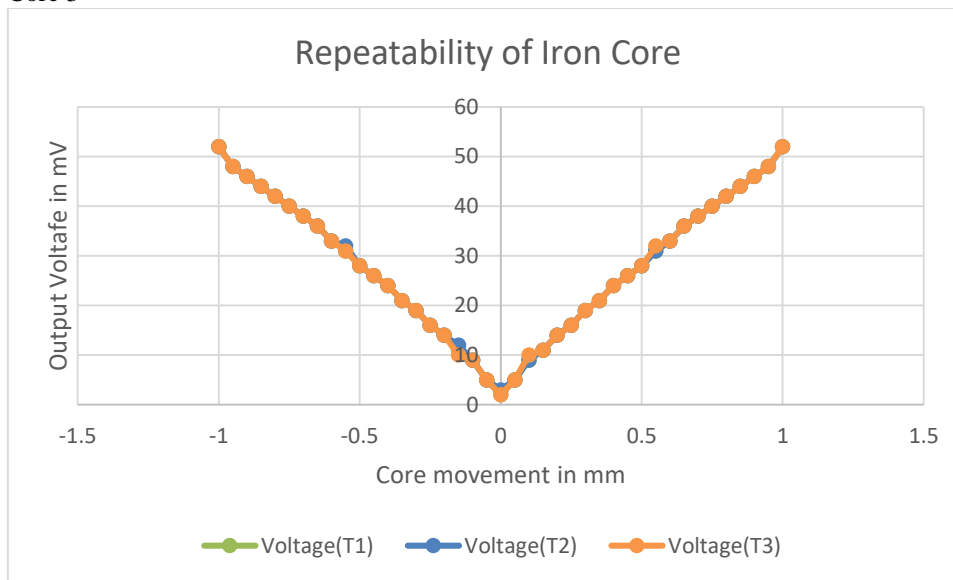

Fig.3.2.1.2 Repeatability graph for core 3

The above graphical representation shows that the graph is almost identical for all three readings, with good repeatability.

Result: -

From all the above graphs for different core materials and wire gauges of all those LVDTs, we can conclude that all of the LVDTs have the same output voltage values for all the experiments throughout the different periods of time.

4. CONCLUSION

A testbed is designed for performance parameter analysis of LVDT, which enables the user to compare theoretical and experimental output generated with a particular combination of core and coil.

Several experiment results for all these linear variable displacement transformers show that the optimum core length is the one with greater length than the primary winding length. In addition, the experiments performed with different core materials suggest that the ferrite core material (Ni-Zn) produces more accurate results than the soft iron core.

For repeatability analysis, the experiments were performed with three different cores. Ferrite core shows slightly better results than the iron core.

These experiments and results show that the optimum design for a linear variable displacement transformer has a core whose length is greater than the primary winding. As a result, ferrite core with 41 SWG gauge wire for coil windings with 3kHz 11pp input voltage is optimum for use having the best accuracy of 0.0541% and highest repeatability. With this, an output voltage in the range of 5 to 78mV can be achieved.

Simple and most efficient linear variable displacement transformer having the primary signal conditioning circuit provides the same efficiency as the standard linear variable displacement transformer available in the industry.

5. REFERENCES

- Mishra, S. K., & Panda, G. (n.d.). A novel method for designing LVDT and its comparison with conventional design. *Proceedings of the 2006 IEEE Sensors Applications Symposium, 2006*. <https://doi.org/10.1109/sas.2006.1634254>
- Repetto, M., & Simkin, J. (1988). Engineering analysis for design optimization of Differential Transformers. *Computer-Aided Engineering Journal*, 5(2), 51. <https://doi.org/10.1049/cae.1988.0013>
- Jefriyanto, W., Saka, B. G., Pineng, M., & Djamal, M. (2020). Development of LVDT (Linear Variable Differential Transformer) sensor as land displacement sensor. *Journal of Physics: Conference Series*, 1528, 012041. <https://doi.org/10.1088/1742-6596/1528/1/012041>
- Pelegrin, J. de, Carvalho, B. M. de, Bertotti, F. L., Lafay, J. M. S., & Pelegrin, J. de. (1970, January 1). *Development and evaluation of a linear variable differential sensor: Semantic scholar*. undefined. Retrieved March 26, 2022, from <https://www.semanticscholar.org/paper/Development-and-evaluation-of-a-linear-variable-Pelegrin-Carvalho/5daefee8ece52a796552489b0e423c506d9ecec4>
- Baidwan, K. I. S., & Kumar, C. R. S. (n.d.). *Design of linear variable differential transformer (LVDT) based displacement sensor with wider linear range characteristics*. The International Journal of Science & Technology. Retrieved March 26, 2022, from <http://internationaljournalcorner.com/index.php/theijst/article/view/124367>

- Saurav, S., Muthuganesh, M., Chaurasia, P. K., & Murugan, S. (2019). Analysis, design, and development of a compact LVDT for in-reactor experiments. *IETE Journal of Education*, 60(2), 95–101. <https://doi.org/10.1080/09747338.2019.1670102>
- Veeraian, P., Gandhi, U., & Mangalanathan, U. (2017). Fractional order linear variable differential transformer: Design and analysis. *AEU - International Journal of Electronics and Communications*, 79, 141–150. <https://doi.org/10.1016/j.aeue.2017.05.037>

